

ENG

BOFFIN II 165 MOTION

Instruction Manual

165
projects

50
components



8+
age

Table of Contents

Basic Troubleshooting	1	DOs and DON'Ts of Building Circuits	12
Parts List	2, 3	Advanced Troubleshooting	13, 14
How to Use Boffin	4	Project Listings	15, 16
Airplane Assembly	5	Projects 1 - 168	17 - 81
Crawler Assembly	6, 7	Notes	82
About Your Boffin Parts	8 - 10	Other Boffin Projects	83
Introduction to Electricity	11		



WARNING FOR ALL PROJECTS WITH A SYMBOL -

Moving parts. Do not touch the motor or fan during operation. Eye protection is recommended.



Conforms to all applicable U.S. government requirements.



WARNING: SHOCK HAZARD - Never connect Boffin to the electrical outlets in your home in any way!



WARNING: CHOKING HAZARD - Small parts. Not for children under 3 years.

Basic Troubleshooting

1. Most circuit problems are due to incorrect assembly, always double-check that your circuit exactly matches the drawing for it.
2. Be sure that parts with positive/negative markings are positioned as per the drawing.
3. Be sure that all connections are securely snapped.
4. Try replacing the batteries.
5. If the light motor (M7) spins but the lights do not turn on, make sure you installed it with the "+" side oriented correctly.

If you suspect you have damaged parts, use the Advanced Troubleshooting procedure on pages 13 and 14 to determine which ones need replacing.

ConQuest entertainment is not responsible for parts damaged due to incorrect wiring.

WARNING: Always check your wiring before turning on a circuit. Never leave a circuit unattended while the batteries are installed. Never connect additional batteries or any other power sources to your circuits. Discard any cracked or broken parts.

Adult Supervision: Because children's abilities vary so much, even with age groups, adults should exercise discretion as to which experiments are suitable and safe (the instructions should enable supervising adults to establish the experiment's suitability for the child). Make sure your child reads and follows all of the relevant instructions and safety procedures, and

keeps them at hand for reference.

This product is intended for use by adults and children who have attained sufficient maturity to read and follow directions and warnings.

Never modify your parts, as doing so may disable important safety features in them, and could put your child at risk of injury.

CAUTION: Persons who are extremely sensitive to flashing lights and rapidly changing colors or patterns should exercise caution when playing with this toy.

Keep this booklet because it contains important information.











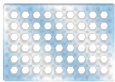





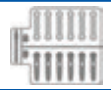









Batteries:

- Use only 1.5V AA type, alkaline batteries (not included).
- Insert batteries with correct polarity.
- Non-rechargeable batteries should not be recharged. Rechargeable batteries should only be charged under adult supervision, and should not be recharged while in the product.
- Do not mix old and new batteries.
- Do not connect batteries or battery holders in parallel.
- Do not mix alkaline, standard (carbon-zinc), or rechargeable (nickel-cadmium) batteries.
- Remove batteries when they are used up.
- Do not short circuit the battery terminals.
- Never throw batteries in a fire or attempt to open its outer casing.
- Batteries are harmful if swallowed, so keep away from small children.























Parts List (Colors and styles may vary) Symbols and Numbers (page 1)

Important: If any parts are missing or damaged, **DO NOT RETURN TO RETAILER**. Call toll-free tel: 284 000 111 or e-mail us at: info@cqe.cz. Customer Service: ConQuest entertainment a.s., Kolbenova 961, 198 00 Praha 9, www.boffin.cz, www.toy.cz.

Qty.	ID	Name	Symbol	Part #	Qty.	ID	Name	Symbol	Part #
☐ 1		Base Grid (11.0" x 7.7")		6SCBG	☐ 1	Ⓒ4	100µF Capacitor		6SCC4
☐ 3	①	1-Snap Wire		6SC01	☐ 1	Ⓒ7	1µF Capacitor		6SCC7
☐ 6	②	2-Snap Wire		6SC02	☐ 1		Crawler Body		6SCCRAWB
☐ 3	③	3-Snap Wire		6SC03	☐ 1		Crawler Parts		6SCCRAWP
☐ 1	④	4-Snap Wire		6SC04	☐ 1	Ⓒ8	Color Light Emitting Diode (LED)		6SCD8
☐ 1	⑤	5-Snap Wire		6SC05	☐ 1	Ⓒ10	Red/Yellow Bicolor Light Emitting Diode (LED)		6SCD10
☐ 1	⑥	6-Snap Wire		6SC06	☐ 1		1.0" Gear		6SCGEAR1
☐ 1	ⒶF	Air Fountain		6SCAF	☐ 2		1.75" Gear		6SCGEAR2
☐ 1		Ball for Air Fountain		6SCAFB	☐ 1		2.55" Gear		6SCGEAR3
☐ 1		Spout for Air Fountain		6SCAFS	☐ 1		3.3" Gear		6SCGEAR4
☐ 2	Ⓑ1	Battery Holder - uses two (2) 1.5V type "AA" (not Included)		6SCB1	☐ 1	ⒸM	Geared Motor		6SCGM
☐ 1		Rubber Band		6SCBAND1	☐ 1		Jumper Wire (Black)		6SCJ1
☐ 1		"+" Shaped Bar		6SCBAR1	☐ 1		Jumper Wire (Red)		6SCJ2

Parts List (Colors and styles may vary) Symbols and Numbers (page 2)

Important: If any parts are missing or damaged, **DO NOT RETURN TO RETAILER.** Call toll-free tel: 284 000 111 or e-mail us at: info@cqe.cz. Customer Service: ConQuest entertainment a.s., Kolbenova 961, 198 00 Praha 9, www.boffin.cz, www.toy.cz

Qty.	ID	Name	Symbol	Part #	Qty.	ID	Name	Symbol	Part #
☐ 1	(M7)	Light Motor		6SCM7	☐ 2		Rubber Ring, 0.375" Dia.		6SCRUBRG
☐ 1		Mini Car		6SCMCAR	☐ 1	(S1)	Slide Switch		6SCS1
☐ 1		Merry-Go-Round Base		6SCMGRB	☐ 1	(S4)	Vibration Switch		6SCS4
☐ 1		Set of Disc Cutouts (4 pcs. / set)		6SCMGRD	☐ 1	(S6)	Switcher		6SCS6
☐ 1		Set of Cardboard Figures (9 pcs. / set)		6SCMGRF	☐ 1	(S7)	Tilt Switch		6SCS7
☐ 1		Airplane Parts (must be punched out)		6SCPLANE	☐ 2		Screw PAW 2.6mm x 6mm		6SCSCREW1
☐ 1		Pivot Stand		6SCPSB	☐ 2		Screw PA 2.3mm x 8mm		6SCSCREW2
☐ 1		0.9" Pulley		6SCPULL1	☐ 1	(SP2)	Speaker		6SCSP2
☐ 1		1.3" Pulley		6SCPULL2	☐ 1	(U2)	Alarm IC		6SCU2
☐ 1		2.1" Pulley		6SCPULL3	☐ 1	(U7)	Motion Detector		6SCU7
☐ 1	(Q2)	NPN Transistor		6SCQ2	☐ 1		Blue Stand		626100
☐ 1	(RV2)	Adjustable Resistor		6SCRV2					

How to Use Boffin

Boffin uses building blocks with snaps to build the different electrical and electronic circuits in the projects. Each block has a function: there are switch blocks, light blocks, battery blocks, different length wire blocks, etc. These blocks are different colors and have numbers on them so that you can easily identify them. The blocks you will be using are shown as color symbols with level numbers next to them, allowing you to easily snap them together to form a circuit.

For Example:

This is the switch block which is green and has the marking **S1** on it. The part symbols in this booklet may not exactly match the appearance of the actual parts, but will clearly identify them.



This is a wire block which is blue and comes in different wire lengths.

This one has the number **2**, **3**, **4**, **5**, or **6** on it depending on the length of the wire connection required.

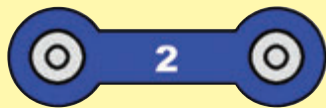

There is also a 1-snap wire that is used as a spacer or for interconnection between different layers.



You need a power source to build each circuit. This is labeled **B1** and requires two (2) 1.5V "AA" batteries (not included).



A large clear plastic base grid is included with this kit to help keep the circuit blocks properly spaced. You will see evenly spaced posts that the different blocks snap into. The base has rows labeled A-G and columns labeled 1-10.

Next to each part in every circuit drawing is a small number in black. This tells you which level the component is placed at. Place all parts on level 1 first, then all of the parts on level 2, then all of the parts on level 3, etc.

Some circuits use the jumper wires to make unusual connections. Just clip them to the metal snaps or as indicated.



The set contains 9 pre-punched cardboard figures, which can be inserted into slots in the merry-go-round base. The figures are supplied as a single sheet; just punch them out.



This set contains 4 pre-punched cardboard discs. These will be used to make hypnotic patterns in project 47, with a strobe light in project 48, and in other projects. The discs are supplied as a single sheet; just punch them out.



To remove a disc from the holder, flip the holder over and poke the disc out with your finger as shown.



Airplane Assembly

Note: The airplane is used in project 27 and others, usually with the light motor (M7) mounted on it.

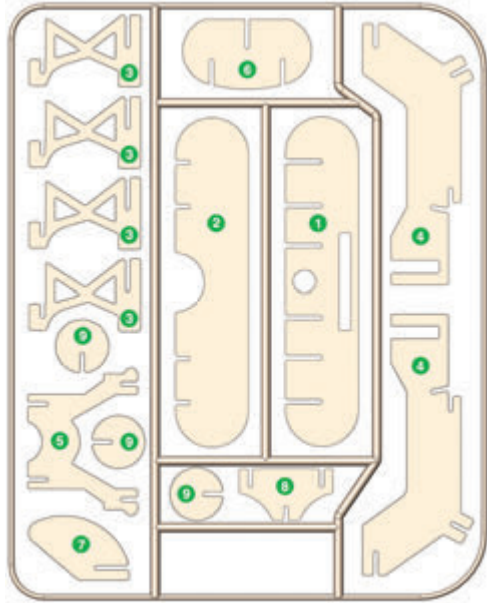

Step 2

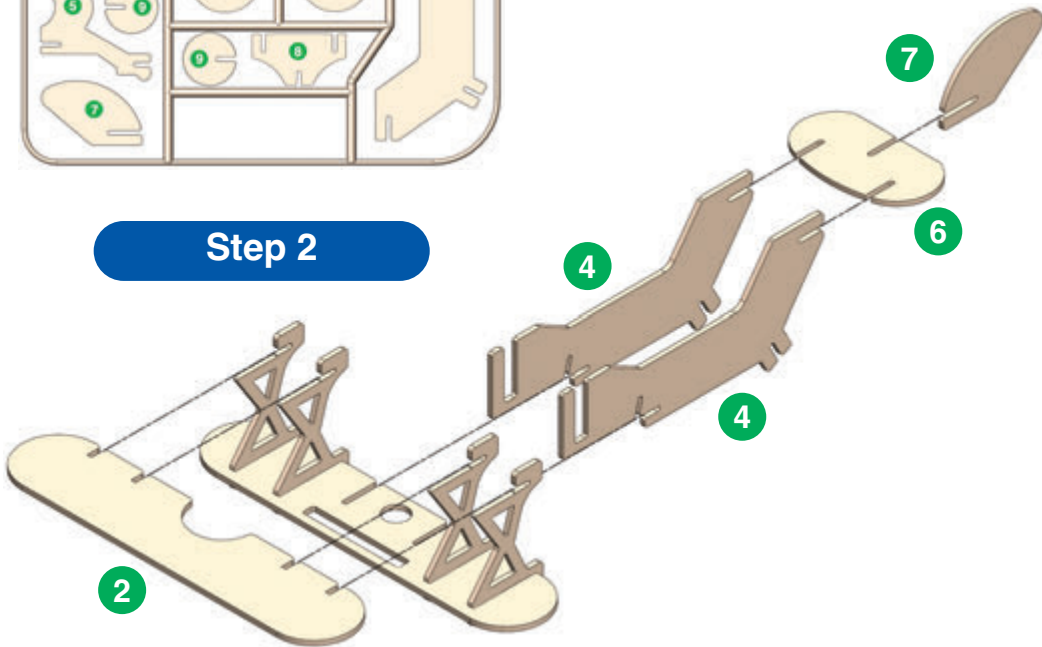

Step 1

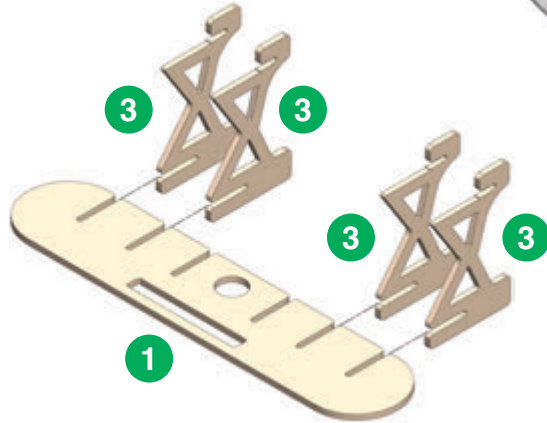

Step 3

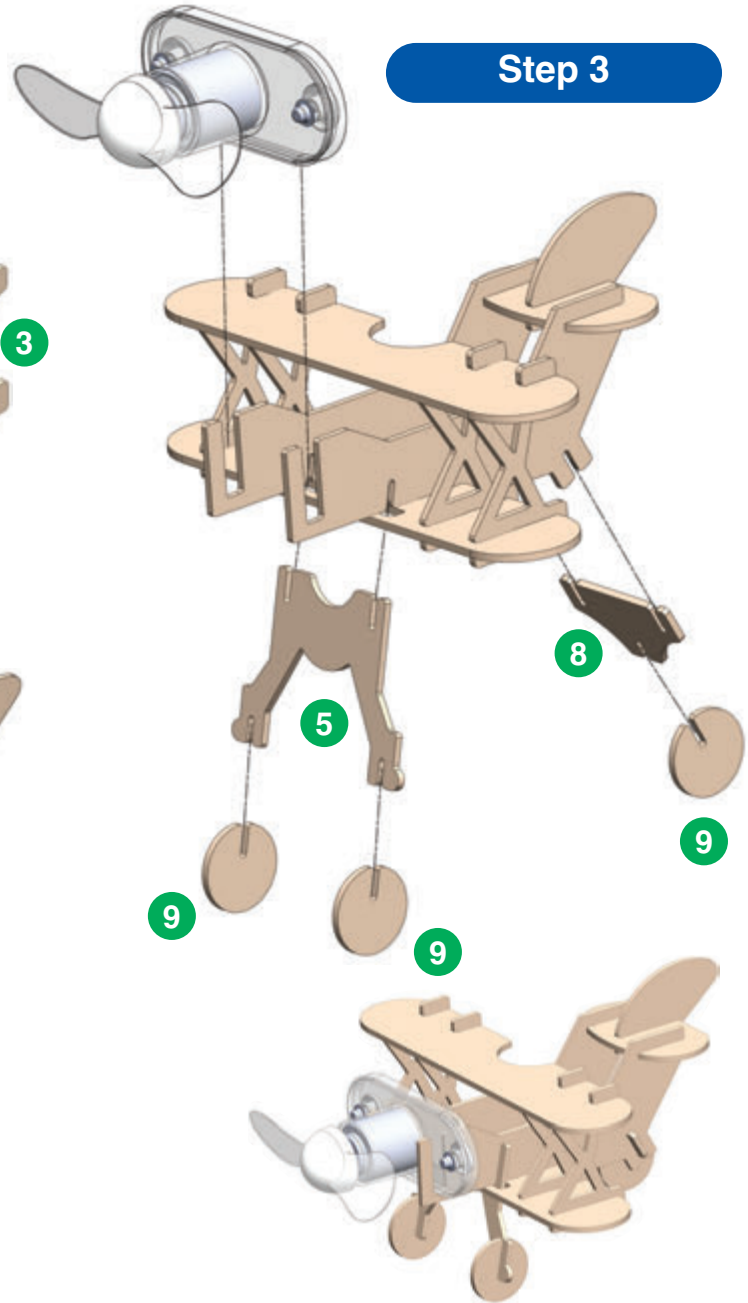

Crawler Assembly

Note: The crawler is used in project 31 and others, usually with the geared motor (GM) mounted on it.

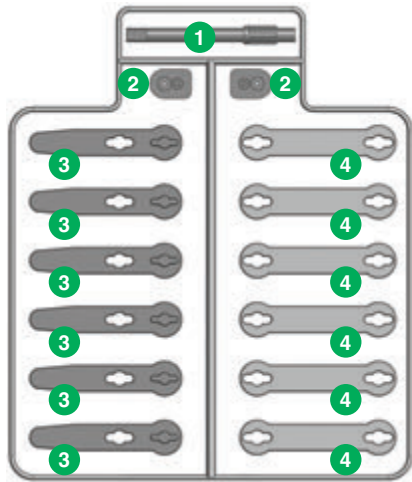

Step 1

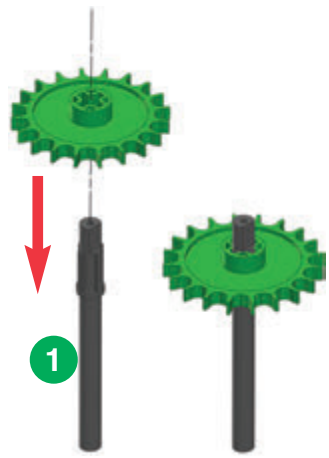

Step 2

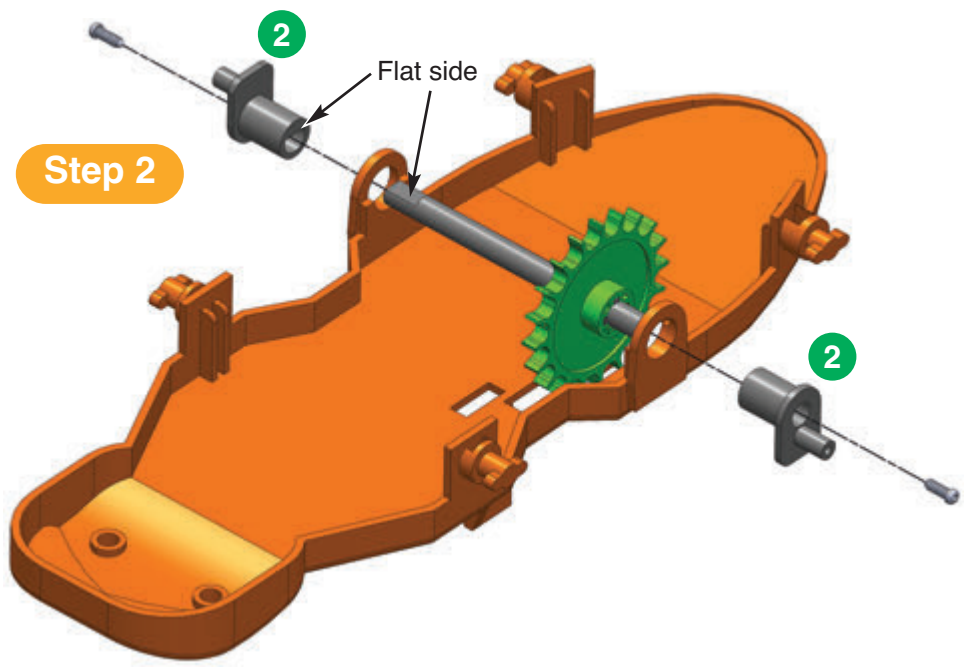

Step 3

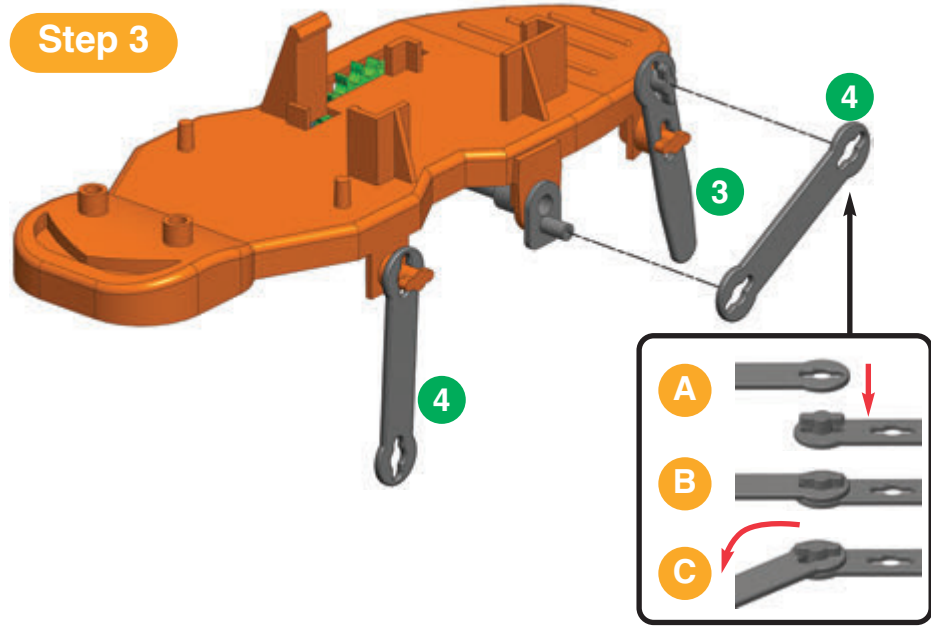

Step 4

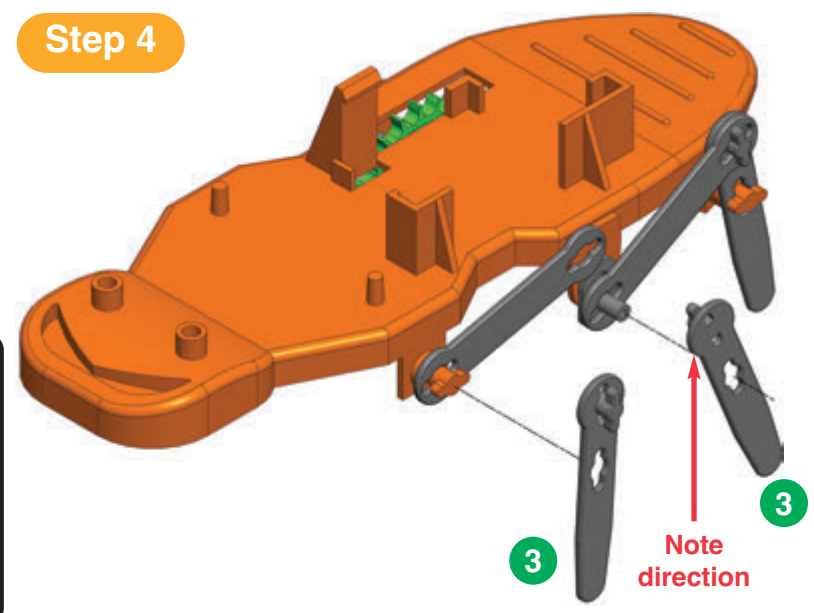

Crawler Assembly

Step 5

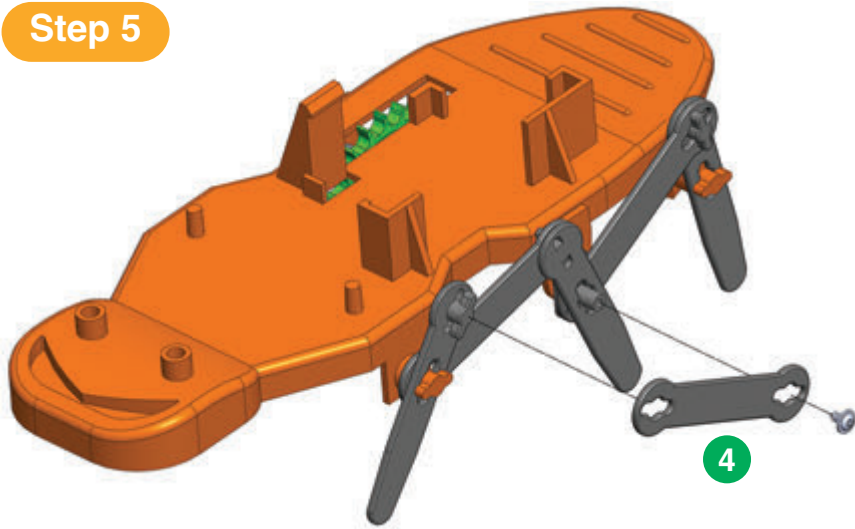

Step 6

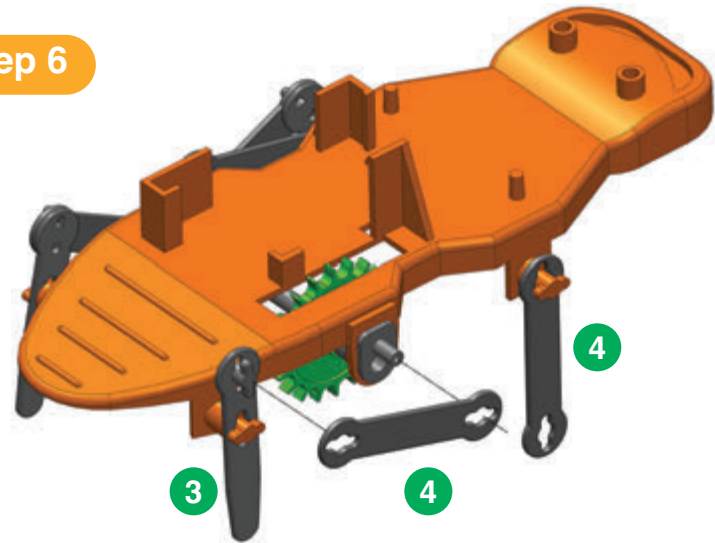

Step 7

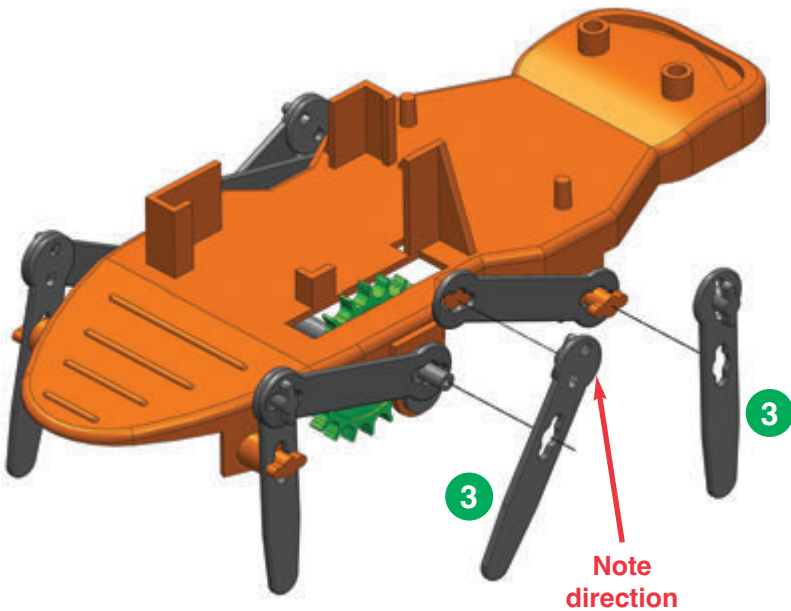

Step 8

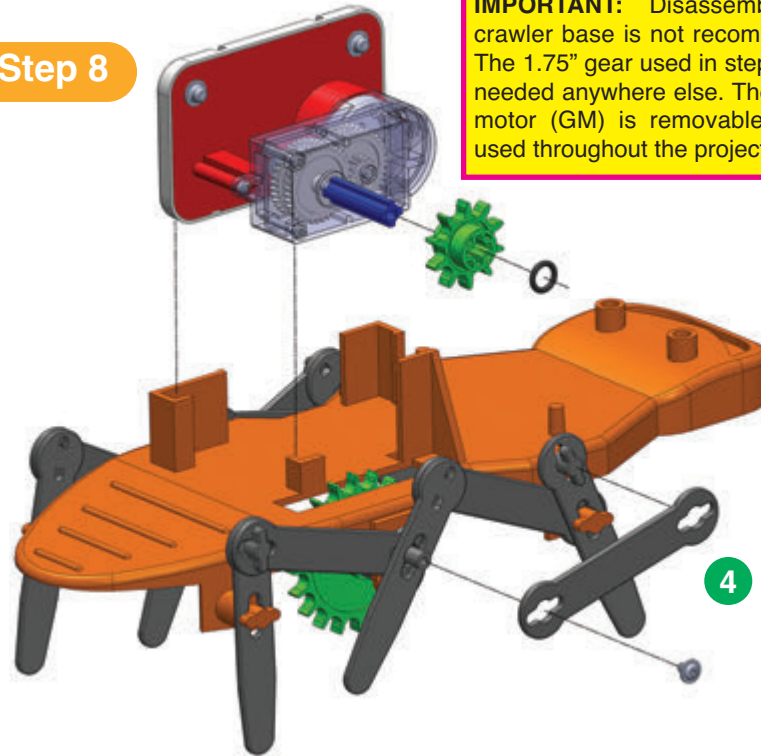

IMPORTANT: Disassembling the crawler base is not recommended. The 1.75" gear used in step 1 is not needed anywhere else. The geared motor (GM) is removable, and is used throughout the projects.

About Your Boffin Parts

(Part designs are subject to change without notice).

BASE GRID

The **base grid** is a platform for mounting parts and wires. It functions like the printed circuit boards used in most electronic products, or like how the walls are used for mounting the electrical wiring in your home.

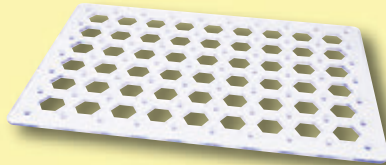

SNAP WIRES & JUMPER WIRES

The blue **snap wires** are wires used to connect components. They are used to transport electricity and do not affect circuit performance. They come in different lengths to allow orderly arrangement of connections on the base grid.

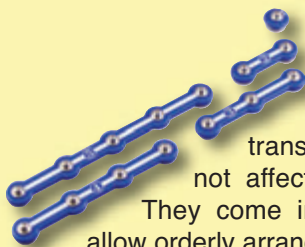

The red and black **jumper wires** make flexible connections for times when using the snap wires would be difficult. They also are used to make connections off the base grid.



Wires transport electricity just like pipes are used to transport water. The colorful plastic coating protects them and prevents electricity from getting in or out.

BATTERY HOLDER

The **batteries (B1)** produce an electrical voltage using a chemical reaction. This “voltage” can be thought of as electrical pressure, pushing electricity through a circuit just like a pump pushes water through pipes. This voltage is much lower and much safer than that used in your house wiring. Using more batteries increases the “pressure”, therefore, more electricity flows.

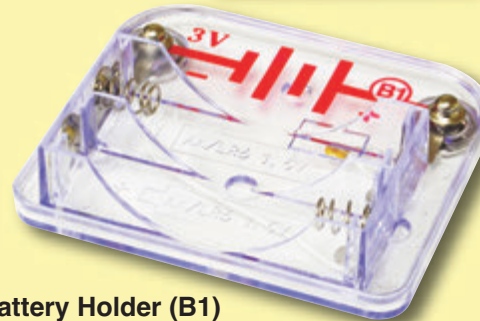
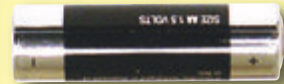

Battery Holder (B1)

SPEAKER

The **speaker (SP2)** converts electricity into sound by making mechanical vibrations. These vibrations create variations in air pressure, which travel across the room. You “hear” sound when your ears feel these air pressure variations.



Speaker (SP2)

SWITCHES

Switches connect (“ON”) or disconnect (“OFF”) the wires in a circuit. When ON they have no effect on circuit performance. Switches turn on electricity just like a faucet turns on water from a pipe. Boffin Motion includes several different switches:

The **slide switch (S1)** is a simple switch like most in your home.

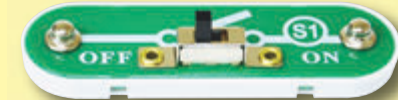

Slide Switch (S1)

The **switcher (S6)** is a more complex switch used to reverse the wires to a component or circuit. See project 2 for an example of connections.



Switcher (S6)

One side of the **vibration switch (S4)** connects to a spring, the other side connects to a wire through the spring. When the spring is shaken, the spring bounces to connect or disconnect the circuit.



Vibration Switch (S4)

The **tilt switch (S7)** has a ball that can roll to make connections between the center and one of the sides.



Tilt Switch (S7)

About Your Boffin Parts

RESISTORS

Resistors “resist” the flow of electricity and are used to control or limit the current in a circuit. Boffin Motion has two resistors (47Ω and $10,000\Omega$) inside the pivot stand, and an adjustable resistor. Materials like metal have very low resistance ($<1\Omega$), while materials like paper, plastic, and air have near-infinite resistance. Increasing circuit resistance reduces the flow of electricity.



Pivot Stand

The **adjustable resistor (RV2)** is a $10,000\Omega$ resistor but with a center tap that can be adjusted between 200Ω and $10,000\Omega$.



Adjustable Resistor (RV2)

CAPACITORS

The $1\mu\text{F}$ and $100\mu\text{F}$ capacitors (C7 & C4) can store electrical pressure (voltage) for periods of time. This storage ability allows them to block stable voltage signals and pass changing ones. Capacitors are used for filtering and delay circuits.

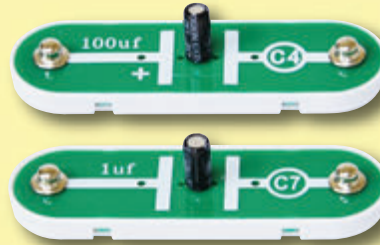

Capacitors (C4 & C7)

MOTOR MODULES

The **light motor (M7)** is a motor with an LED circuit mounted on its shaft. A motor converts electricity into mechanical motion, in the form of a spinning shaft. In the light motor electricity is transported through the motor shaft to power an LED circuit, with LEDs mounted on the fan blade. The motor spins in both directions, but the light circuit only works in one direction.

How does electricity turn the shaft in the motor? Electricity is closely related to magnetism, and an electric current flowing in a wire has a magnetic field similar to that of a very, very tiny magnet. Inside the motor is three coils of wire with many loops. If a large electric current flows through the loops, the magnetic effects become concentrated enough to move the coils. The motor has a magnet inside, so as the electricity moves the coils to align them with the permanent magnet, the shaft spins.



Light Motor (M7)

The **air fountain (AF)** has a motor and fan inside. The fan sucks air in from the side and pushes it out the top. As the air comes out it spreads out like a fountain of water and can balance light round objects like the ball. Reversing the voltage to the air fountain reduces the power of the airflow due to the shape of the fan.



Air Fountain

The **geared motor (GM)** is a motor with a gearbox attached. The gearbox makes the attached “+” shaped shaft spin slower but with more force than the shaft that is directly attached to the motor.

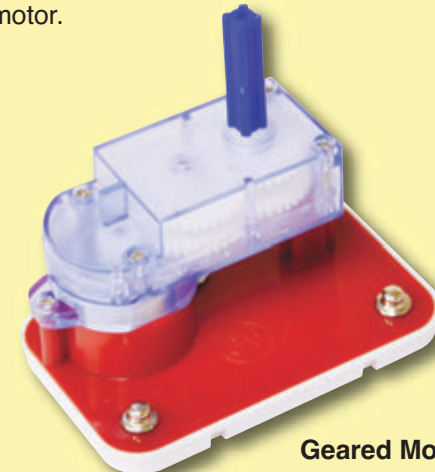

Geared Motor

About Your Boffin Parts

TRANSISTORS

The **NPN transistor (Q2)** uses a small electric current to control a large current, and is used in switching, amplifier, and buffering applications. Transistors are easy to miniaturize, and are the main building blocks of integrated circuits including the microprocessor and memory circuits in computers.



NPN Transistor (Q2)

LEDs

The **color LED (D8)** and **red/yellow bicolor LED (D10)** are light emitting diodes, and may be thought of as a special one-way light bulbs. In the “forward” direction, (indicated by the “arrow” in the symbol) electricity flows if the voltage exceeds a turn-on threshold (about 1.5V for red, slightly higher for yellow, about 2.0V for green, and about 3.0V for blue); brightness then increases. The color LED contains red, green, and blue LEDs, with a micro-circuit controlling them. The red/yellow bicolor LED contains red & yellow LEDs in connected in opposite directions. A high current will burn out an LED, so the current must be limited by other components in the circuit (though your Boffin LEDs have internal resistors to protect against incorrect wiring). LEDs block electricity in the “reverse” direction.

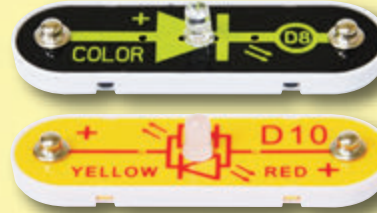

LEDs (D8 & D10)

ELECTRONIC MODULES

The **alarm IC (U2)** contains a specialized sound-generation integrated circuit (IC) and other supporting components (resistors, capacitors, and transistors) that are always needed with it. A schematic for it is available at www.boffin.cz.



Connections:

IN1, IN2, IN3 - control inputs
(-) - power return to batteries
OUT - output connection

Connect control inputs to (+) power to make five alarm sounds, see project 39 for an example of proper connections.

The **motion detector (U7)** contains an infrared detector, amplifier-filter circuit, and timing circuit. A schematic for it is available at www.boffin.cz.

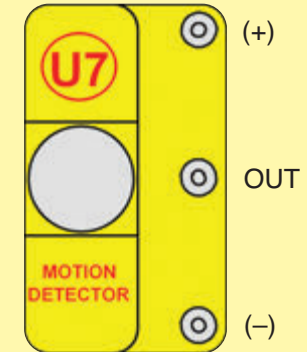

Connections:

(+) - regulated power from batteries
(-) - power return to batteries
OUT - output connection
Lens

All objects (including people and animals) produce infrared radiation due to the heat in them. Infrared radiation is similar to visible light but has a longer wavelength that our eyes cannot detect. The lens on top of the motion detector module filters and focuses the radiation, it is most sensitive to the radiation produced by our bodies.

Inside the motion detector module is an infrared detector with pyroelectric crystals, which create a tiny voltage when exposed to infrared radiation. A circuit amplifies and filters this voltage, but only responds to changes in the radiation level - so is only triggered by moving objects (motion). When motion is detected a timing circuit is used to control other snap circuits devices for a few seconds, such as an alarm.

Introduction to Electricity

What is electricity? Nobody really knows. We only know how to produce it, understand its properties, and how to control it. Electricity is the movement of sub-atomic charged particles (called **electrons**) through a material due to electrical pressure across the material, such as from a battery.

Power sources, such as batteries, push electricity through a circuit, like a pump pushes water through pipes. Wires carry electricity, like pipes carry water. Devices like LEDs, motors, and speakers use the energy in electricity to do things. Switches and transistors control the flow of electricity like valves and faucets control water. Resistors limit the flow of electricity.

The electrical pressure exerted by a battery or other power source is called **voltage** and is measured in **volts** (V). Notice the “+” and “-” signs on the battery; these indicate which direction the battery will “pump” the electricity.

The **electric current** is a measure of how fast electricity is flowing in a wire, just as the water current describes how fast water is flowing in a pipe. It is expressed in **amperes** (A) or **milliamps** (mA, 1/1000 of an ampere).

The “**power**” of electricity is a measure of how fast energy is moving through a wire. It is a combination of the voltage and current (Power = Voltage x Current). It is expressed in **watts** (W).

The **resistance** of a component or circuit represents how much it resists the electrical pressure (voltage) and limits the flow of electric current. The relationship is Voltage = Current x Resistance. When the resistance increases, less current flows. Resistance is measured in **ohms** (Ω), or **kilo ohms** ($k\Omega$, 1000 ohms).

Nearly all of the electricity used in our world is produced at enormous generators driven by steam or water pressure. Wires are used to efficiently transport this energy to homes and businesses where it is used. Motors convert the electricity back into mechanical form to drive machinery and appliances. The most important aspect of electricity in our society is that it allows energy to be easily transported over distances.

Note that “distances” includes not just large distances but also tiny distances. Try to imagine a plumbing structure of the same complexity as the circuitry inside a portable radio - it would have to be large because we can't make water pipes so small. Electricity allows complex designs to be made very small.

There are two ways of arranging parts in a circuit, in series or in parallel. Here are examples:

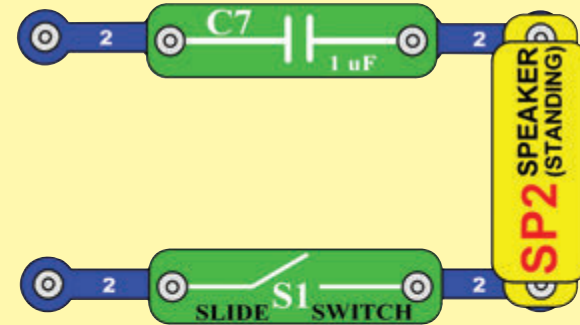

Series Circuit

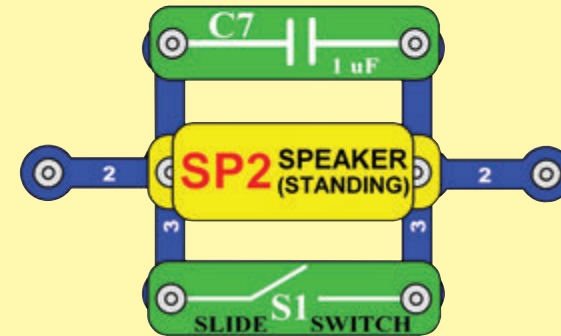

Parallel Circuit

Placing components in series increases the resistance; highest value dominates. Placing components in parallel decreases the resistance; lowest value dominates.

The parts within these series and parallel sub-circuits may be arranged in different ways without changing what the circuit does. Large circuits are made of combinations of smaller series and parallel circuits.

DOs and DON'Ts of Building Circuits

After building the circuits given in this booklet, you may wish to experiment on your own. Use the projects in this booklet as a guide, as many important design concepts are introduced throughout them. Every circuit will include a power source (the batteries), a resistance (which might be a resistor, capacitor, motor, integrated circuit, etc.), and wiring paths between them and back. **You must be careful not to create "short circuits" (very low-resistance paths across the batteries, see examples at right) as this will damage components and/or quickly drain your batteries.** Only connect the alarm IC (U2) and motion detector (U7) using configurations given in the projects, incorrectly doing so may damage them. ConQuest entertainment is **not responsible for parts damaged due to incorrect wiring.**

Here are some important guidelines:

- ALWAYS** USE EYE PROTECTION WHEN EXPERIMENTING ON YOUR OWN.
- ALWAYS** include at least one component that will limit the current through a circuit, such as the speaker, capacitors, ICs (which must be connected properly), light or geared motors, air fountain, or resistors.
- ALWAYS** use LEDs, transistors, and switches in conjunction with other components that will limit the current through them. Failure to do so will create a short circuit and/or damage those parts.
- ALWAYS** connect capacitors so that the "+" side gets the higher voltage.
- ALWAYS** disconnect your batteries immediately and check your wiring if something appears to be getting hot.
- ALWAYS** check your wiring before turning on a circuit.
- ALWAYS** connect the alarm IC (U2) and motion detector (U7) using configurations given in the projects or as per the connection description on page 10.
- NEVER** connect to an electrical outlet in your home in any way.
- NEVER** leave a circuit unattended when it is turned on.
- NEVER** touch the light motor when it is spinning.

For all of the projects given in this book, the parts may be arranged in different ways without changing the circuit. For example, the order of parts connected in series or in parallel does not matter — what matters is how combinations of these sub-circuits are arranged together.

You are encouraged to tell us about new programs and circuits you create.

If they are unique, we will post them with your name and state on our website at: www.toy.cz. Send your suggestions to ConQuest entertainment: info@toy.cz.

Examples of SHORT CIRCUITS - NEVER DO THESE!!!

Placing a 3-snap wire directly across the batteries is a SHORT CIRCUIT.



NEVER DO!

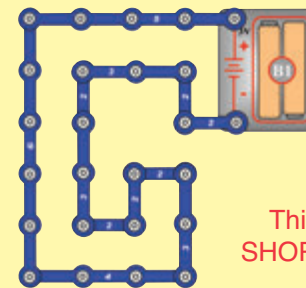
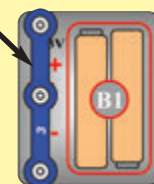

NEVER DO!

This is also a SHORT CIRCUIT.

When the slide switch (S1) is turned on, this large circuit has a SHORT CIRCUIT path (as shown by the arrows). The short circuit prevents any other portions of the circuit from ever working.

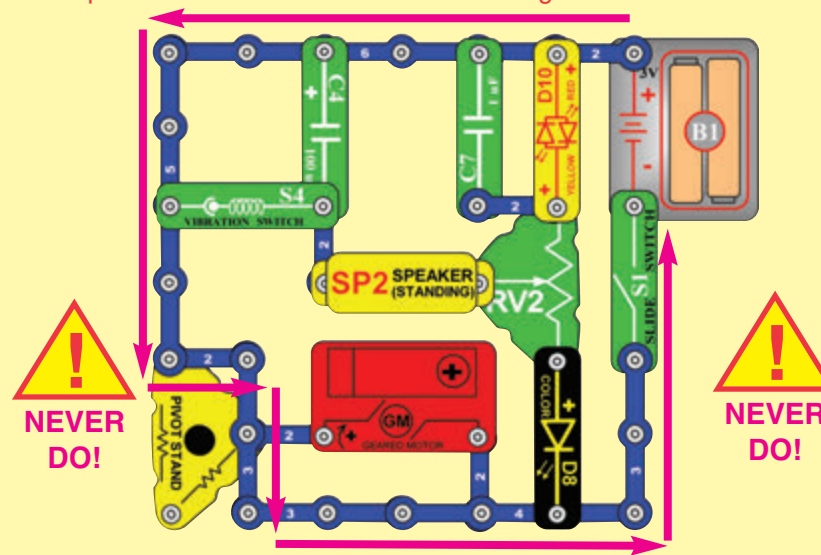

NEVER DO!



NEVER DO!



WARNING: SHOCK HAZARD - Never connect Boffin to the electrical outlets in your home in any way!



Warning to Boffin owners: Do not connect additional voltage sources from other sets, or you may damage your parts. Contact ConQuest entertainment if you have questions or need guidance.

Advanced Troubleshooting (Adult supervision recommended)

ConQuest entertainment is not responsible for parts damaged due to incorrect wiring.

If you suspect you have damaged parts, you can follow this procedure to systematically determine which ones need replacing:

(Note: Some of these tests connect an LED directly across the batteries without another component to limit the current. Normally this might damage the LED, however Boffin LEDs have internal resistors added to protect them from incorrect wiring, and will not be damaged.)

1. Color LED (D8), red/yellow bicolor LED (D10), speaker (SP2), geared motor (GM), and battery holder (B1):

- Place batteries in holder.
- Place the color LED directly across the battery holder (LED + to battery +), it should light and be changing colors.
- Place the red/yellow bicolor LED directly across the battery holder, in both orientations. It should light red when the red side is to battery +, and yellow when the yellow side is to battery +.
- “Tap” the speaker across the battery holder contacts, you should hear static as it touches.
- Place the geared motor directly across the battery holder; its shaft should spin.
- If none of the above work, then replace your batteries and repeat. If still bad, then the battery holder is damaged. Test both battery holders.

2. Red & black jumper wires:

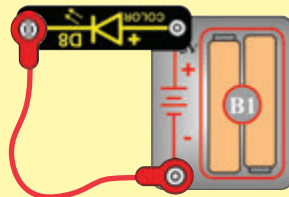

3. Snap wires:

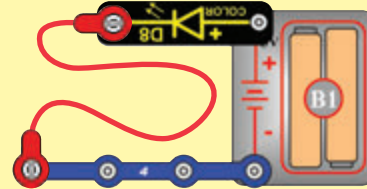

4. Slide switch (S1) and vibration switch (S4):

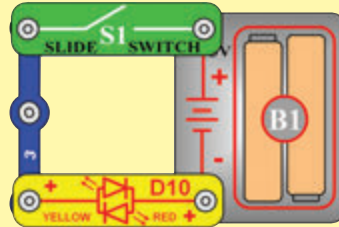

5. Light motor (M7):

6. Air fountain (AF):

7. Pivot stand resistors:

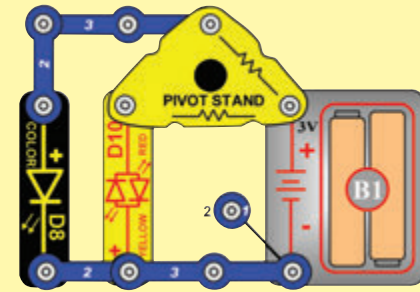

8. Adjustable resistor (RV2):

9. NPN transistor (Q2):

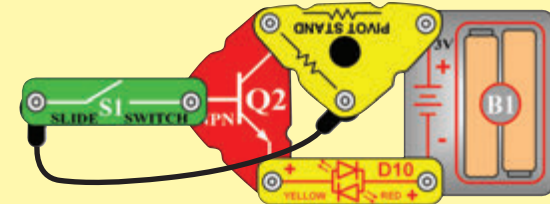

10. Tilt switch (S7):

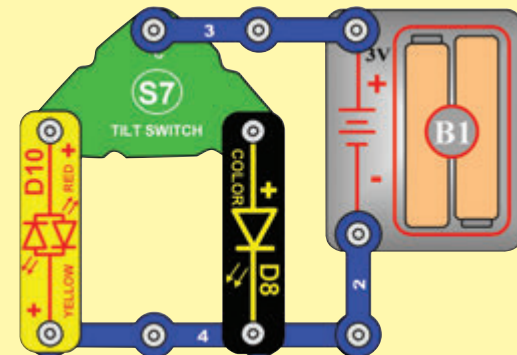

Advanced Troubleshooting (Adult supervision recommended)

11. **Alarm IC (U2):** Build project 158, and the variants for it. Each arrangement should produce a siren sound, or U2 is broken.
12. **Motion Detector (U7):** Build project 18. The LED (D8) should light for a few seconds on power-up and then whenever the circuit detects motion.
13. **Switcher (S6):** Build this mini-circuit. The LED (D10) should be red when S6 is in the top position, off when S6 is in the middle position, and yellow when S6 is in the bottom position; otherwise S6 is broken.

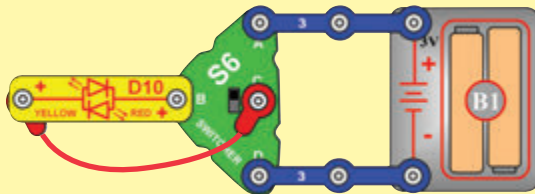

14. **1 μ F (C7) and 100 μ F (C4) capacitors:** Build project 139. Touch C4 or C7 across points A & B, then across points C & D; the LED (D10) should flash (brightly for C4 and dimly for C7) or the capacitor is broken.

ConQuest entertainment a. s.
Kolbenova 961, 198 00 Praha 9,
www.boffin.cz, www.toy.cz
info@boffin.cz

Project Listings

Project #	Description	Page #	Project #	Description	Page #	Project #	Description	Page #
1	Color Light	17	29	Idling Plane	26	57	Secure Pulley	38
2	Reversible Light	17	30	Light Plane	26	58	More Pulleys	38
3	Light Show	18	31	Crawler	27	59	Trip-Wire Lights	38
4	Dim Light Show	18	32	Crawler with Control Light	27	60	Triple Lights Motion	39
5	Vibration, Tilt, & Motion Detector	18	33	High Speed Crawler	27	61	Double Lights Motion	39
6	Dancing Ball	19	34	Crawler with On-Board Control	28	62	Big Circuit	40
7	High Power Dancing Ball	19	35	Crawler with Control Light	28	63	Vib Off	40
8	Human Height Control	19	36	Crawler with Motion Light	28	64	Audio Triple Detector	41
9	Double Dancer	19	37	Tilt Motion	29	65	Vibration Plane	41
10	Low Double Dancer	19	38	Tilt Alarm	29	66	Too Much at Once?	42
11	Vibration Light	20	39	Alarm Sounds & Lights	30	67	Not Too Much at Once	43
12	Vibration Alarm	20	40	Softer Alarms	30	68	Adjustable Motor & More	44
13	Tilt Sensor	20	41	Funky Colors Alarms	30	69	Adjustable Dancing Ball	44
14	Super Motion Detector	21	42	Lighthouse	31	70	Color Brightness Adjuster	45
15	Short Spin Lights & Sound	21	43	Merry-Go-Round	31	71	Red or Yellow Brightness Adjuster	45
16	Louder Short Spin Lights & Sound	21	44	Fast Merry-Go-Round	31	72	Yellow Brightness Adjuster	45
17	Motion Detector Light	22	45	Merry-Go-Round with Music & Light	32	73	Double Brightness Adjuster	45
18	Low Power Motion Detector	22	46	Fast Merry-Go-Round with Music & Light	32	74	Two-Way Double Brightness Adjuster	46
19	Motion Detector Alarms	23	47	Hypnotic Discs	33	75	Parallel Double Brightness Adjuster	46
20	Merry-Go-Round Motion Detector	23	48	Strobe Light with Music	33	76	Dim Double Brightness Adjuster	46
21	Mini Car	24	49	Slow Merry-Go-Round	34	77	Secret Resistors	47
22	Mini Car with Control Light	24	50	Merry-Go-Round with Lights	34	78	Adjustable Alarm Sounds & Light	47
23	High Speed Car	24	51	Fun with Gears	35	79	Stable Adjustable Alarm Sounds & Light	47
24	Mini Car with On-Board Control	25	52	Higher Gear Ratio	35	80	Adjustable Volume Alarms	47
25	Mini Car with Light	25	53	Spin Draw	35	81	Double Red Siren	48
26	Mini Car with Motion Light	25	54	Strobe Light	36	82	Double Lights Siren	48
27	It's a Plane!	26	55	Make Your Own Patterns	37	83	Super Vibration Light	49
28	Low Power Plane	26	56	Fun with Pulleys	37	84	Fast Vibration Light	49

Project Listings

Project #	Description	Page #	Project #	Description	Page #	Project #	Description	Page #
85	Vibration Alarms & Lights	49	113	Super Charge & Discharge	58	141	Short Burst Machine Gun	70
86	Shaky Alarms & Lights	49	114	Mini Charge & Discharge	58	142	Short Burst Sound & Lights	70
87	Reversible Merry-Go-Round	50	115	Light Start	59	143	Short-On Light	70
88	Two-Way Circuit	50	116	Double Motion	59	144	Finger Touch Light	71
89	Low Power Two-Way Circuit	50	117	Triple Motion	60	145	Slow Off Light	71
90	Slow Off Tilt Alarm	51	118	Slow Triple Motion	60	146	3-Position Switch	71
91	Slow Off Tilt Light	51	119	Dominator	60	147	One Way Electricity	72
92	Switcher Fun	51	120	Lots at Once	61	148	Tilt Sound & Light	72
93	Adjustable Slow Off Tilt Light	52	121	Electrical Circle	61	149	Inflator	73
94	Color Slow Off Tilt Light	52	122	Generator	62	150	Transistor	73
95	Very Slow Off Tilt Light	52	123	Leverage	62	151	Slow Light	74
96	Bright Slow Off Tilt Light	52	124	Generator Load	62	152	Wiggler	74
97	Adjustable Slow Off Vibration Light	53	125	Water Alarm	63	153	Blinker Beeper	75
98	Color Slow Off Vibration Light	53	126	Human Alarm	63	154	Blinker Blinker	75
99	Very Slow Off Vibration Light	53	127	Draw an Alarm	63	155	Blinker Control	75
100	Bright Slow Off Vibration Light	53	128	Human & Water Light	64	156	Red Lights First	76
101	Slow Off Tilt Lights	54	129	Conduction Detector	64	157	Red Just Before Yellow	76
102	Very Slow Off Tilt Lights	54	130	Trip-Wire Alarm	64	158	Loud Sirens	77
103	Slow Off Vibration Lights	54	131	Current Limiters	65	159	Adjustable Volume Sirens	77
104	Very Slow Off Vibration Lights	54	132	Current Limiters in Parallel	65	160	Capacitors in Series	78
105	Tilted Motion Detector	55	133	Current Director	66	161	Capacitors in Parallel	78
106	Tilt Off	55	134	Reversible Current Director	67	162	Adjustable Low Speed Fan	79
107	Electricity In, Electricity Out	56	135	Lazy Fan	68	163	Adjustable Light Motor	79
108	Little Electricity In/Out	56	136	Lazy Merry-Go-Round	68	164	Transistor Control	80
109	Mini Rechargeable Battery	56	137	Lazy Lights	68	165	Reversible Motor	80
110	Mini Rechargeable Batteries	57	138	Very Lazy Lights	68	166	Slow Reversible Motor	80
111	Left Right Bright Lights	57	139	Electricity You Can Walk Away With	69	167	Orange Light	81
112	Charge & Discharge	58	140	Electricity You Can Walk Away With (II)	69	168	Light, Sound, & Flight	81



Project 1

Color Light

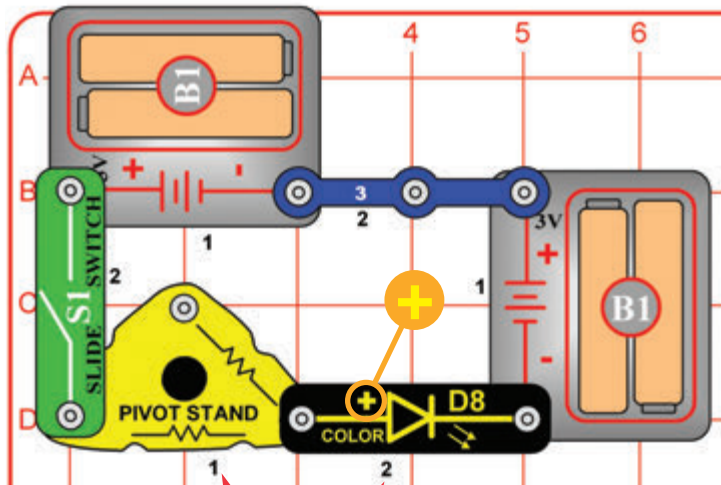

Placement Level Numbers

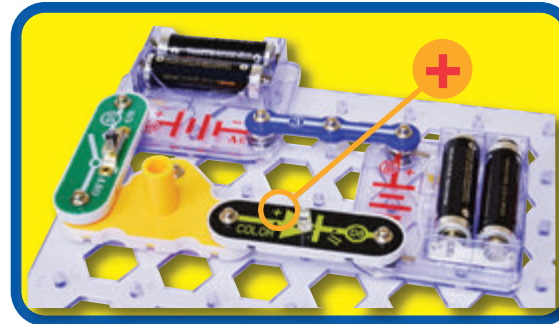

Snappy says the color LED actually contains separate red, green, and blue lights, with a micro-circuit controlling them.

The pivot stand is used here because it has internal resistors that limit the flow of electricity, and help protect the color LED from damage.



Boffin uses electronic blocks that snap onto a clear plastic grid to build different circuits. These blocks have different colors and numbers on them so that you can easily identify them.

Build the circuit shown on the left by placing all the parts with a black 1 next to them on the board first. Then, assemble parts marked with a 2.

Install two (2) "AA" batteries (not included) into each of the battery holders (B1) if you have not done so already.

Turn on the slide switch (S1), and enjoy the light show from the color LED (D8). For best effects, dim the room lights.

Try replacing the color LED with the red/yellow bicolor LED (D10), orienting it in either direction.

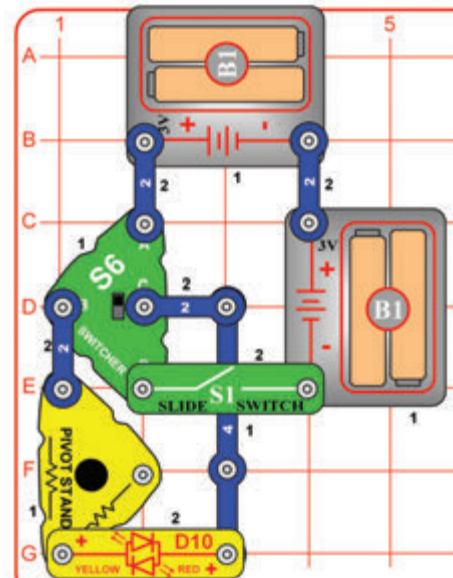

Project 2

Reversible Light

Build the circuit as shown, turn on the slide switch (S1), and then set the switcher (S6) at each of its 3 positions. The red/yellow bicolor LED (D10) should be yellow at the top S6 position, off at the middle position, and red at the bottom S6 position. For best effects, dim the room lights.

Try replacing the red/yellow bicolor LED with the color LED (D8, "+" on left). The color LED isn't bidirectional, so it only works at the top S6 position.

LEDs are light emitting diodes, which are like little light bulbs that only work in one direction. The red/yellow bicolor LED is actually a red LED and a yellow LED, connected in opposite directions inside the same part.





Project 3

Light Show

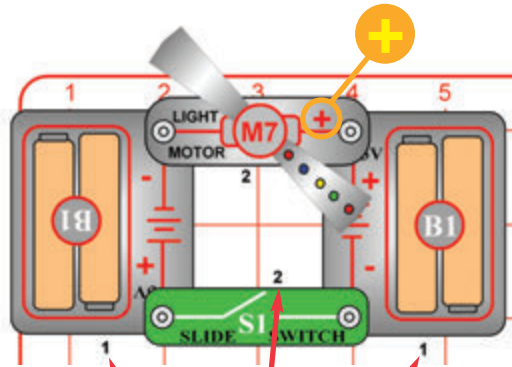

Placement Level Numbers



WARNING: Moving parts. Do not touch the fan during operation.

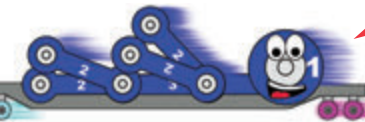

The fan on the light motor has several LEDs, similar to the ones in the D8 & D10 LEDs. Electricity is transported through the motor shaft to power the LEDs.

Boffin uses electronic blocks that snap onto a clear plastic grid to build different circuits. These blocks have different colors and numbers on them so that you can easily identify them.

Build the circuit shown on the left by placing all the parts with a black 1 next to them on the board first. Then, assemble parts marked with a 2. Install two (2) "AA" batteries (not included) into each of the battery holders (B1) if you have not done so already.

Turn on the slide switch (S1) and watch the light show! For best effects, dim the room lights.

Never touch the fan while it is spinning.



Project 4

Dim Light Show

Use the preceding circuit, but replace one of the battery holders (B1) with a 3-snap wire. The circuit works the same but is much dimmer, giving some interesting effects. For best effects, view in a dimly lit room.



Project 5

Vibration, Tilt, & Motion Detector

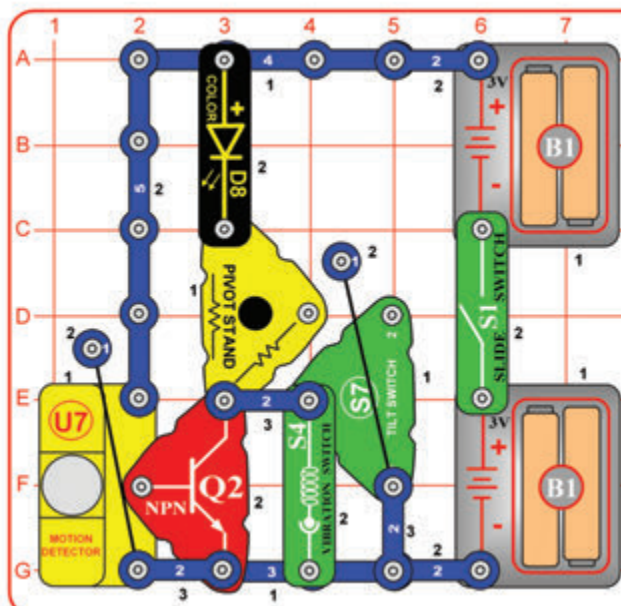

Build the circuit and turn on the slide switch (S1). The color LED (D8) lights for a few seconds on start-up, and then whenever the circuit detects motion, feels vibration, or is tilted in some directions.

Project 6 Dancing Ball

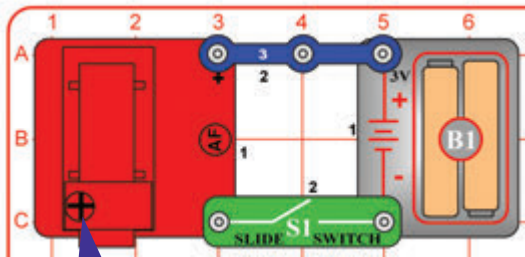

Place the spout on top of the air fountain and the ball in the air flow.

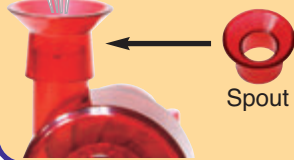

Build the circuit as shown, place the spout on the air fountain (AF), turn on the slide switch (S1), then place the ball directly in the blowing air above the air fountain. The blowing air should balance the ball, so it floats in the air and “dances”. Occasionally the ball may become unstable and fall out; just place it back into the air flow.

If desired, you may draw lines or patterns on the ball. New alkaline batteries are recommended for this project.

Project 7 High Power Dancing Ball

Use the preceding circuit, but replace the 3-snap wire with a second battery holder (B1). The circuit works the same but the blowing air flow is stronger, making the ball float higher but also making it unstable. As a result, the ball may fall out quickly.

Try replacing the ball with other small, light balls in your home and see which ones float in the airflow.

Project 8 Human Height Control

Use the preceding circuit, but place your fingers or thumb in front of the air intake on the side of the air fountain, to partially block it. You can make the ball float lower in the air by restricting the airflow. This may make the ball be more stable and stay in the air longer.

Project 9

Double Dancer

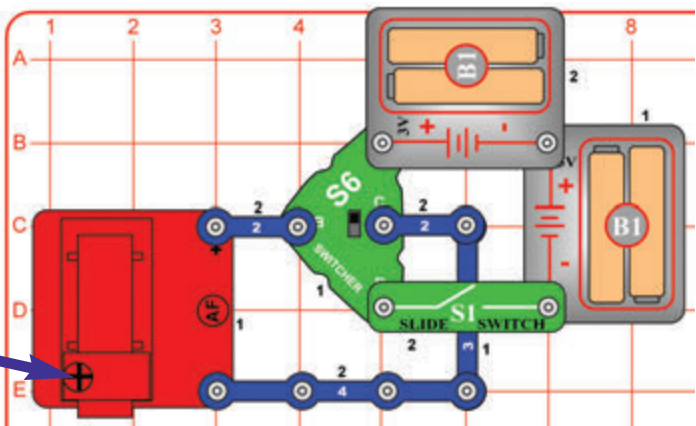

Build this circuit, turn on the slide switch (S1), set the switcher (S6) to either the top or bottom position, and place the ball in the air flow above the spout on the air fountain (AF). See how long the ball floats in the air for each S6 setting.

The top S6 setting has stronger air flow, but it may be too strong, causing the ball to become unstable and fall out. The bottom S6 setting makes the air flow a little weaker, so the ball may be more stable and float in the air better.

Try replacing the ball with other small, light balls in your home and see which ones float in the airflow.

Project 10 Low Double Dancer

Use the preceding circuit, but replace one of the battery holders with a 3-snap wire. The circuit works the same but the blowing air flow is weaker. The ball may wiggle around without rising into the air.

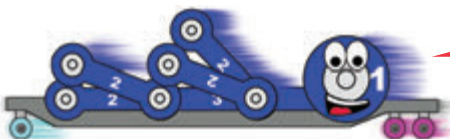

The air is being blown by a fan blade inside the air fountain. The switcher (S6) reverses the direction that the fan spins, but the shape of the fan makes the air flow stronger in one direction.



Project 11 Vibration Light

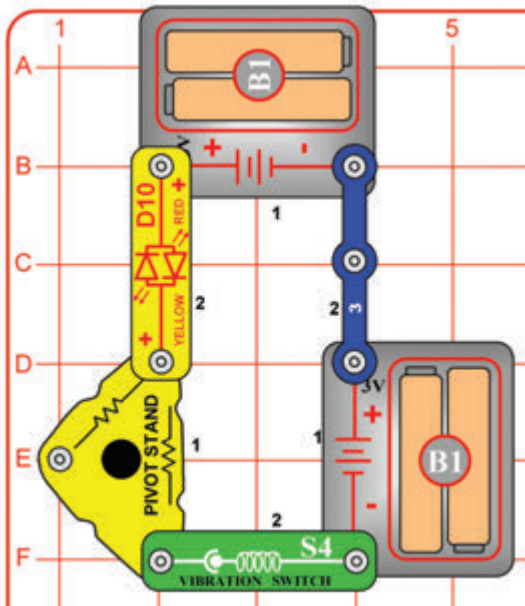

Build the circuit as shown. Tap on the vibration switch (S4) or bang on the table to make the red/yellow LED (D10) light.

One side of the vibration switch connects to a spring, and the other side connects to a contact next to the spring. When the switch is shaken, the spring bounces to open or close the circuit.



Project 12 Vibration Alarm

Build the circuit as shown. Tap on the vibration switch (S4) or bang on the table to sound an alarm.

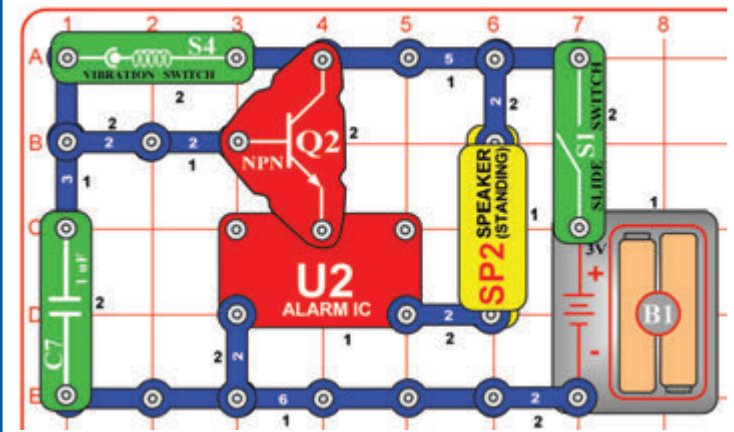

Project 13

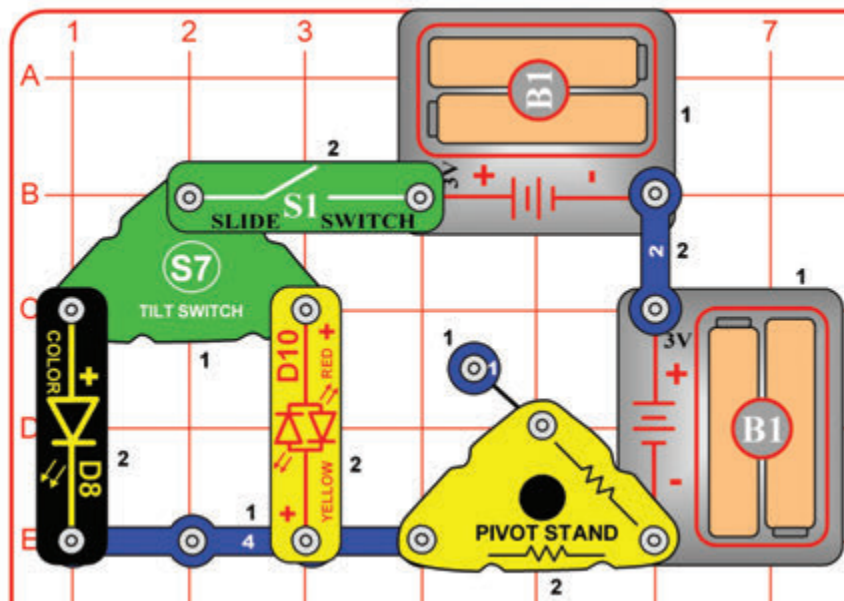

Build the circuit as shown and turn on the slide switch (S1). The color LED (D8) or red/yellow LED (D10) will light if the circuit is tilted or moved. Experiment to see which tilt angles activate which LED.

If the circuit does not shut off when left alone on a flat surface, then tilt it slightly so it turns off.

The tilt switch (S7) contains a ball, which activates contacts when it rolls to either side due to tilt or motion.





Project 14

Super Motion Detector

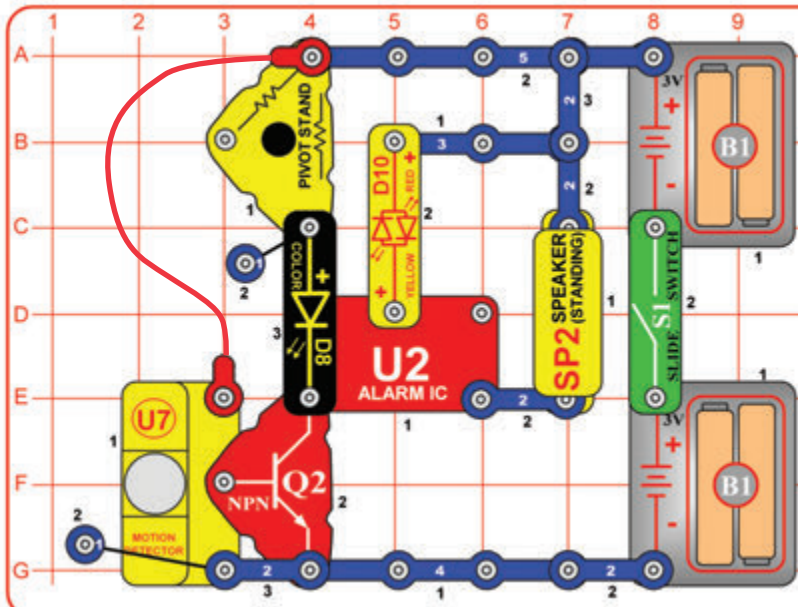

Mount circuit on the blue stand and face across a room.

Assemble the circuit and place the base grid into the blue stand (with the NPN transistor (Q2) closest to the stand) and carefully stand it up. Position it near the edge of a table, facing across a room.

Turn on the slide switch (S1). The color LED (D8) lights and an alarm sounds for a few seconds on start-up, and then whenever the circuit detects motion in the room.

This circuit will work in the dark, but be careful not to hurt yourself moving around a room in the dark.

Objects that generate heat, including people and animals, also produce infrared radiation. Infrared radiation cannot be seen with our eyes, but can be detected.

The motion detector (U7) is designed to detect changes in infrared radiation, especially the type emitted by people. The NPN transistor (Q2) acts as an amplifier, helping the motion detector turn on the color LED and alarm.

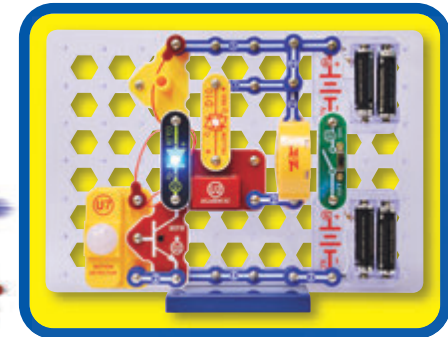

Project 15 Short Spin Lights & Sound

Project 16 Louder Short Spin Lights & Sound

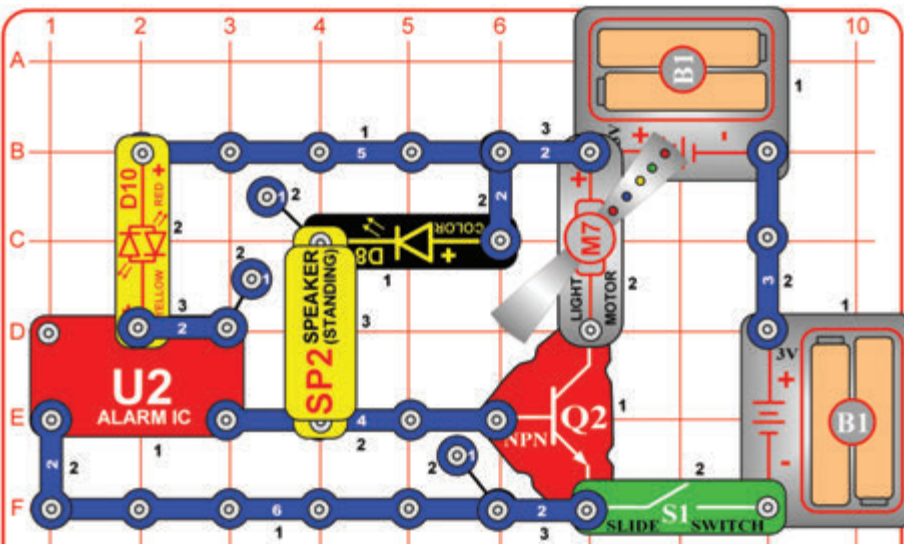

Build the circuit and turn on the slide switch (S1). The light motor (M7) spins in short bursts, synchronized with a machine gun-like sound.

This is one of my favorite circuits!



Use the preceding circuit but replace the color LED (D8) with a 3-snap wire. The sound is louder now, and the movement of the light motor (M7) is a little different.



Project 17

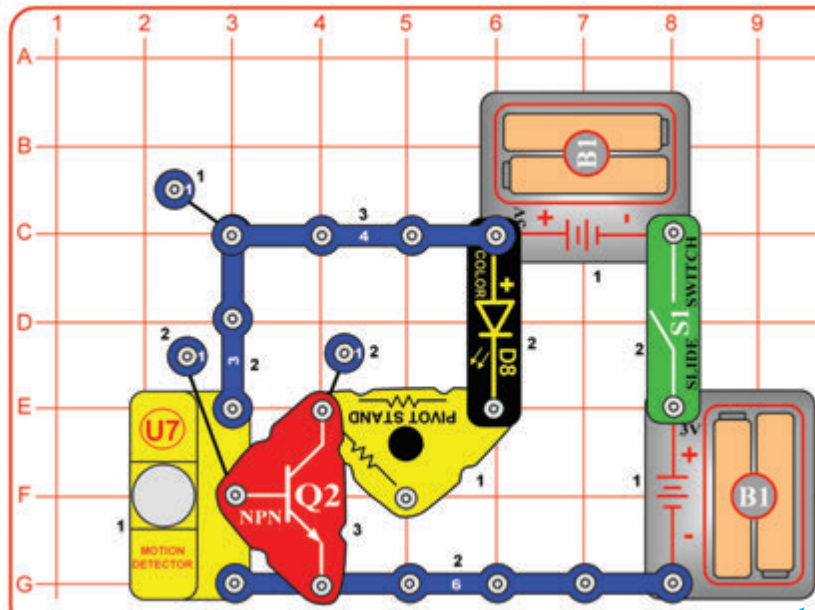

Motion Detector Light

Assemble the circuit and place the base grid into the blue stand (with the NPN transistor (Q2) closest to the stand) and carefully stand it up. Position it near the edge of a table, facing across a room.

Turn on the slide switch (S1). The color LED (D8) lights for a few seconds on start-up, and then whenever the circuit detects motion in the room.

This circuit will work in the dark, but be careful not to hurt yourself moving around a room in the dark.



Mount circuit on the blue stand and face across a room.



Project 18

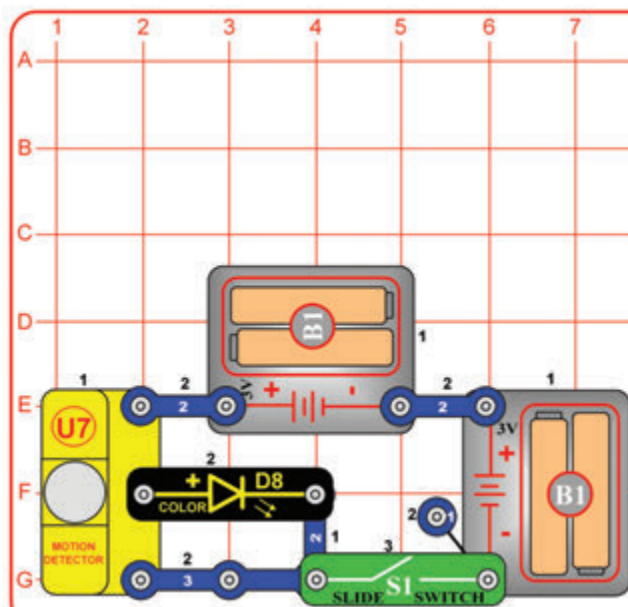

Low Power Motion Detector

Place the base grid into the blue stand (with the slide switch (S1) closest to the stand) and carefully stand it up. Position it near the edge of a table, facing across a room.

Turn on the slide switch (S1). The color LED (D8) lights for a few seconds on start-up, and then whenever the circuit detects motion in the room.

The color LED will not be as bright as it was in the preceding circuit, because this circuit does not have the NPN transistor (Q2) as an amplifier. This circuit uses less electricity than projects 14 & 17, so your batteries will last longer.



Mount circuit on the blue stand and face across a room.



Project 19

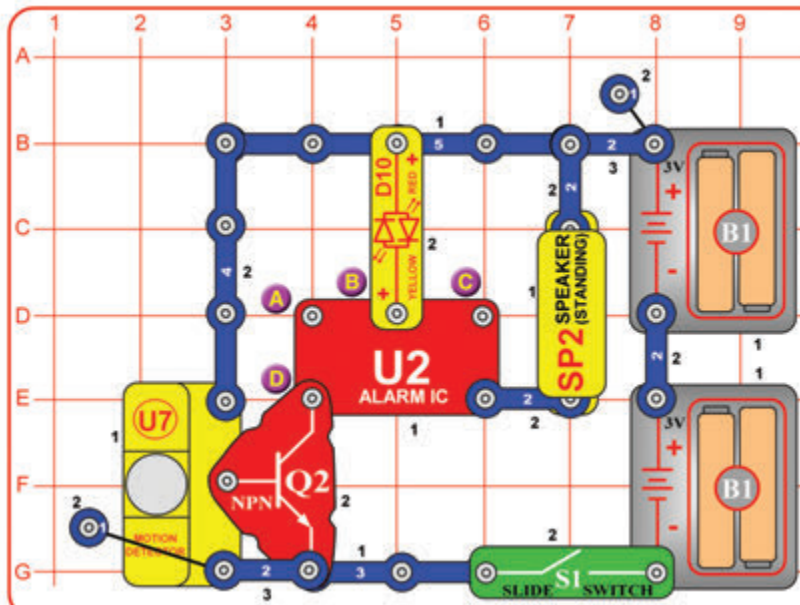

Motion Detector Alarms

Assemble the circuit and place the base grid into the blue stand (with the slide switch (S1) closest to the stand) and carefully stand it up. Position it near the edge of a table, facing across a room.

Turn on the slide switch (S1). An alarm sounds for a few seconds on start-up, and then whenever the circuit detects motion in the room.

This circuit will work in the dark, but be careful not to hurt yourself moving around a room in the dark.

Variant A: Add a connection between the points marked B & C using a 1-snap and a 2-snap. Now it sounds like a machine gun.

Variant B: Remove the connection between B & C, and add a connection between A & B. Now it sounds like a fire engine.

Variant C: Remove the connection between A & B, and add a connection between A & D. Now it sounds like a European siren.



Project 20

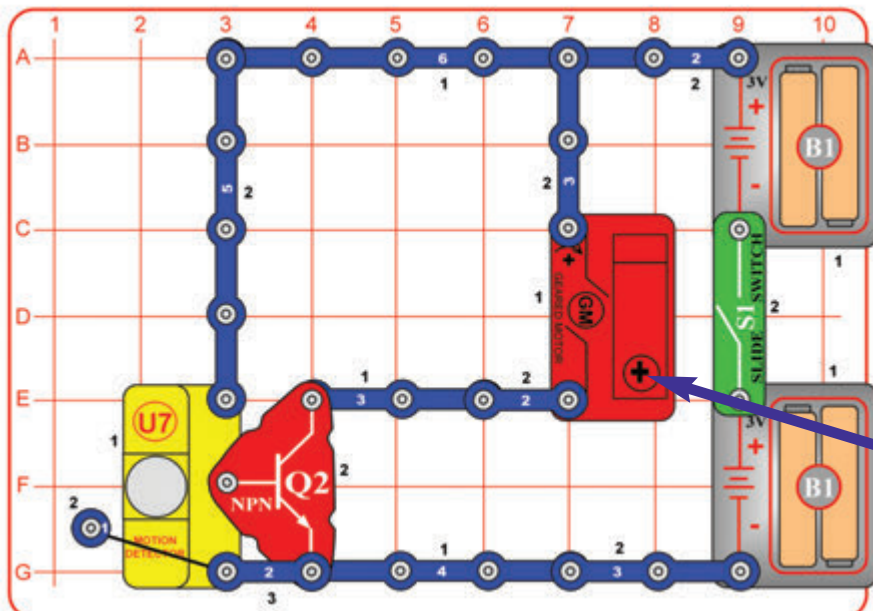

Merry-Go-Round Motion Detector

Assemble the circuit and mount the merry-go-round base on the geared motor (GM) shaft. Place cardboard figures on the merry-go-round if desired.

Turn on the slide switch (S1). The merry-go-round spins for a few seconds on start-up, and then whenever the circuit detects motion in the room.

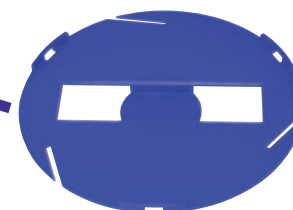



Project 21

Mini Car

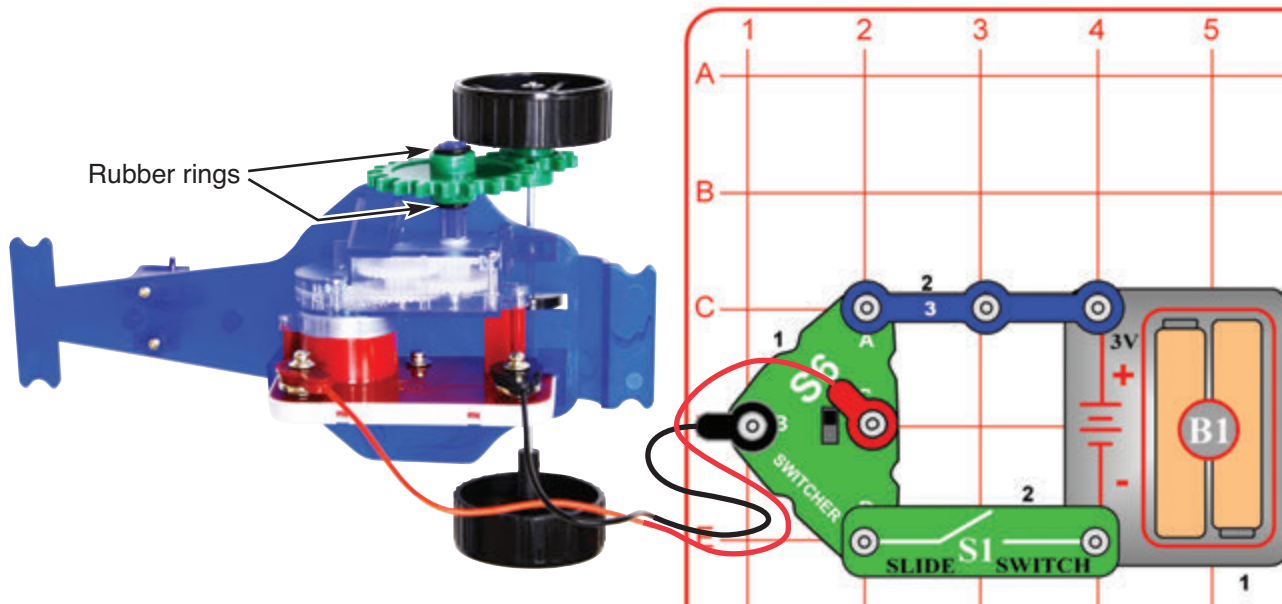

Build the circuit as shown. Mount the 1.75" gear on the geared motor (GM) with the rubber rings to keep it from sliding out of position, place it on the mini car frame, and connect it to the circuit using the red & black jumper wires. Turn on the slide switch (S1), and then use the switch (S6) to make the mini car go forward, backward-turning, or stop. You can follow the car around the room or table carrying the base grid while using S6 to control it. Be careful to follow it closely so you don't over-extend the jumper wires, and to keep it from falling off the table.



Project 22

Mini Car with Control Light

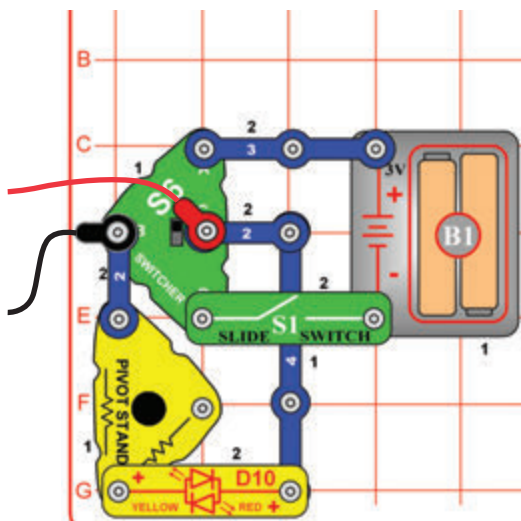

Modify the preceding circuit to include the red/yellow bicolor LED (D10), which lights yellow when the car is going forward, or red when it goes backward-turning.



Project 23

High Speed Car

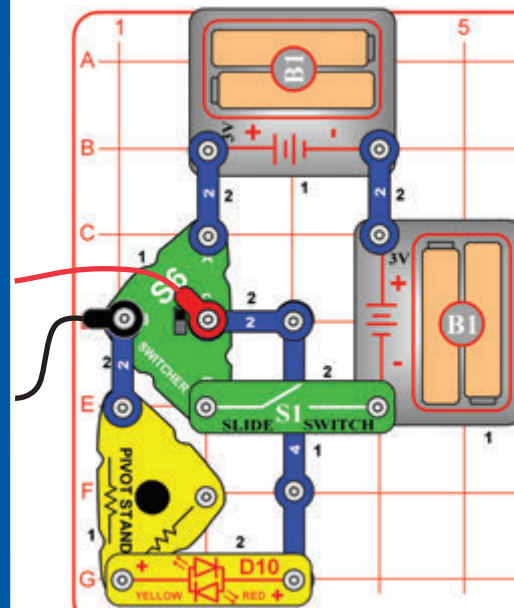

Modify the preceding circuit to use a second battery holder (B1), as shown. The car is much faster now, but more difficult to control.

Project 24

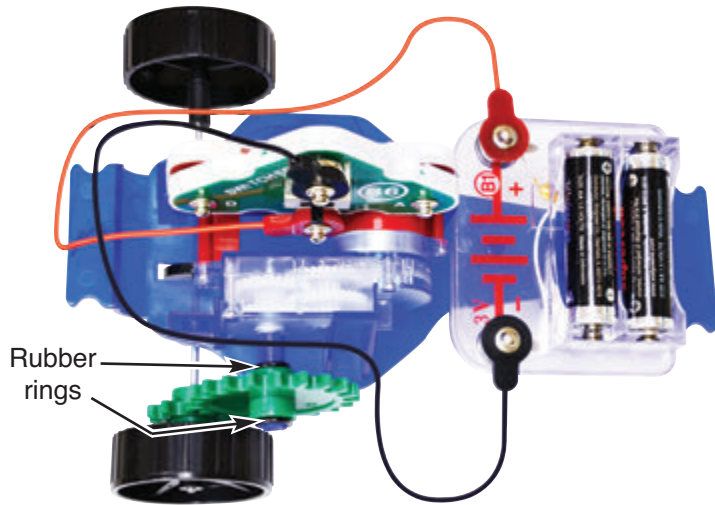

Mini Car with On-Board Control

Build the circuit shown here. Mount the 1.75" gear on the geared motor (GM) with the rubber rings to keep it from sliding out of position, and place it on the mini car frame. Place the switcher (S6) directly on the geared motor, set S6 to the middle position, place a battery holder (B1) on the front of the mini car frame, connect the red jumper wire from + on B1 to C on S6, then connect black wire from - on B1 to B on S6. Be sure the jumper wires will not interfere with the gears or wheels.

Set S6 to the "A" side to make the mini car go forward, or set it to the "D" side to make the mini car go backwards and turn. Be careful that the mini car does not fall off a table or down a stairway!

Project 25 Mini Car with Light

Add the color LED (D8) directly on top of the jumper wire connections to the battery holder (B1, LED + to battery +). Alternately, you can use the red/yellow bicolor LED (D10), oriented in either direction.

Remove the LED when you are finished. Note that normally connecting an LED directly to a battery can damage the LED, but the color LED has an internal resistor that will protect it.

Project 26

Mini Car with Motion Light

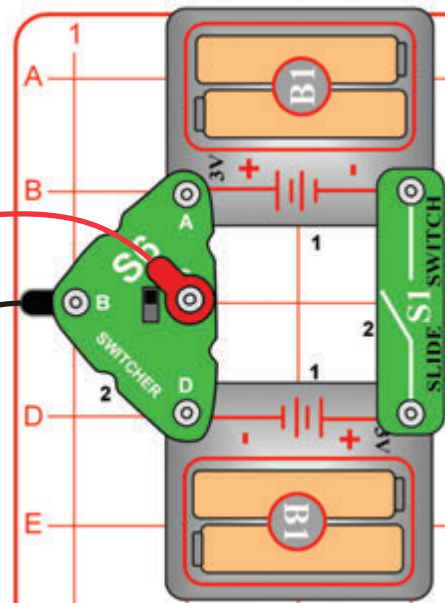
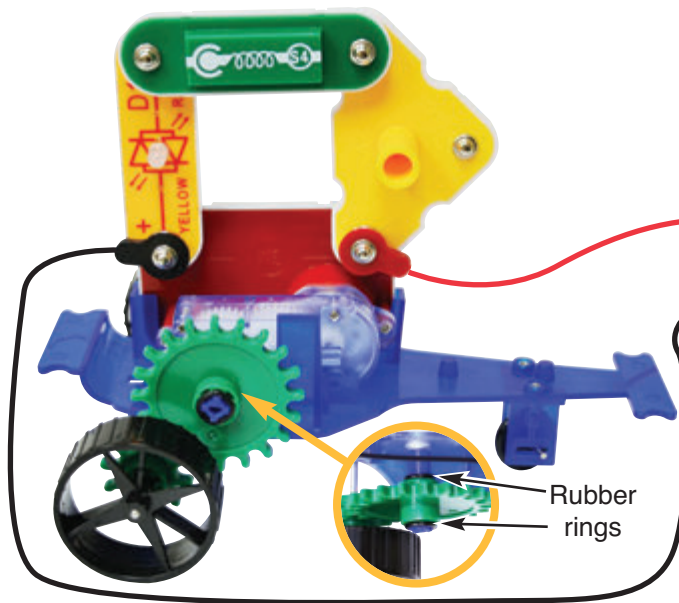

Mount the 1.75" gear on the geared motor (GM), with the rubber rings to keep it from sliding out of position, and place it on the mini car frame. Mount the red/yellow bicolor LED (D10), vibration switch (S4), and pivot stand to the geared motor in the arrangement shown, and connect to the circuit on the base grid using the red & black jumper wires as shown.

Turn on the slide switch (S1), and then use the switcher (S6) to make the mini car go forward, backward-turn, or stop. When the mini car is moving, vibrations will often light the red/yellow LED. You can follow the mini car around the room or table carrying the base grid while using S6 to control it. Be careful to follow it closely so you don't over-extend the jumper wires, and to keep it from falling off the table.

Project 27

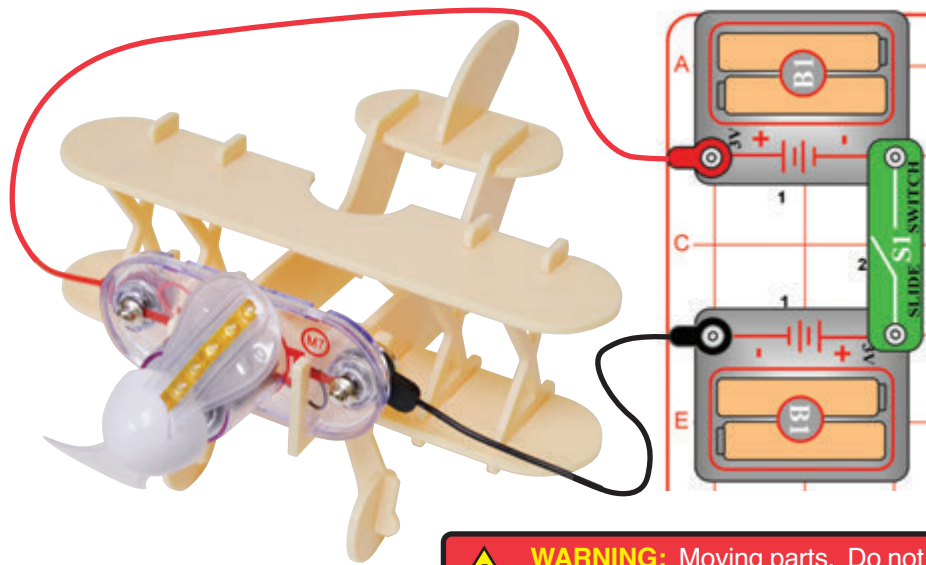

WARNING: Moving parts. Do not touch the fan during operation.

It's a Plane!

Assemble the airplane using the instructions on page 5, install the light motor (M7) into the front of it, build the circuit shown here, and connect the red & black jumper wires to the light motor (red to "+"). Spread out the jumper wires and be sure they will not interfere with the fan on the light motor.

Place the airplane on a smooth surface and turn on the slide switch (S1). The fan on the light motor spins and lights, and the airplane slowly moves around due to vibration.

Project 28 Low Power Plane

Use the preceding circuit, but replace one of the battery holders (B1) with a 3-snap wire. The circuit works the same but is much dimmer, giving some interesting effects. For best effects, view in a dimly lit room.

Project 29 Idling Plane

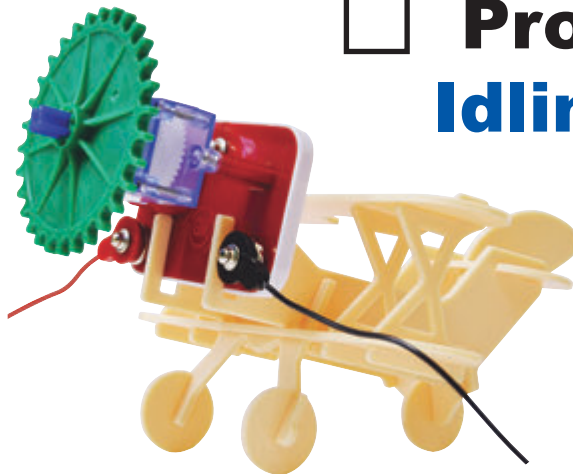

Use either of the two preceding circuit, but replace the light motor (M7) with the geared motor (GM). Place the 2.55" gear on the "+" shaft of the geared motor, and mount the geared motor on the plane as shown.

Turn on the slide switch (S1) and the gear spins like a propellor. The plane appears to be idling with the motor running, and getting ready to take off.

Project 30 Light Plane

Use this circuit, mount the color LED (D8) on the airplane and the red & black jumper wires to it (red to "+").

Turn on the slide switch (S1) and the LED shines. The plane will not move.

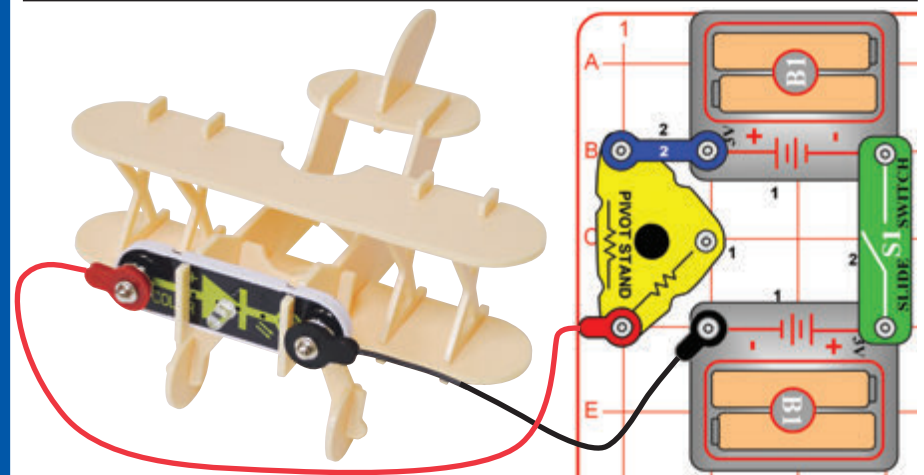



Project 31

Crawler

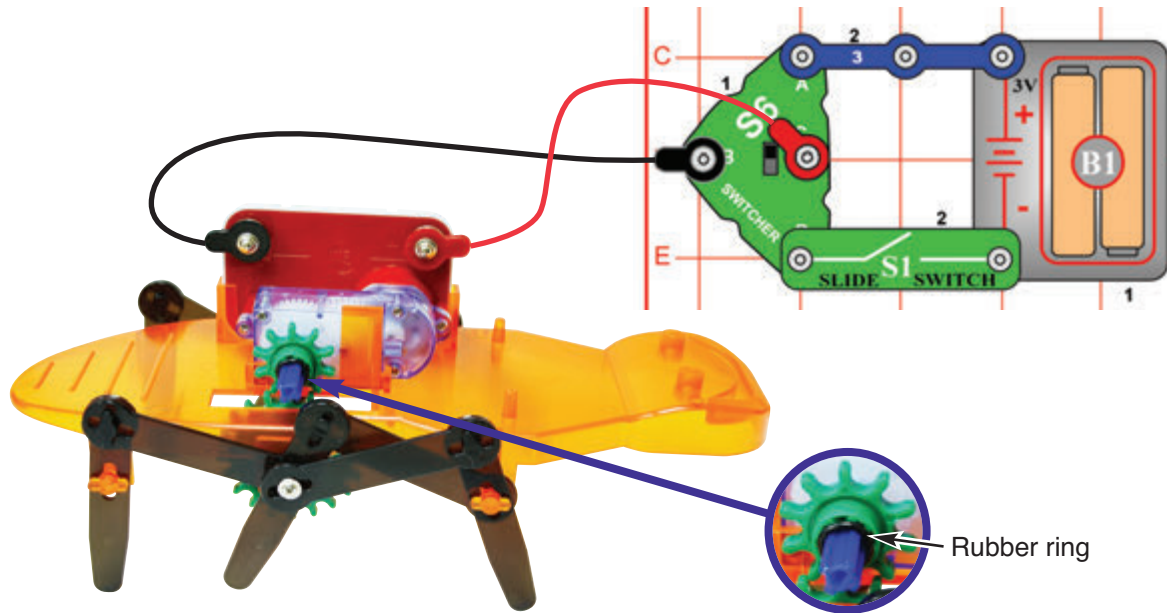

Assemble the crawler using the assembly instructions on pages 6 and 7, and build the circuit shown here. Mount the smallest gear (1.0") on the geared motor (GM) with a rubber ring to keep it from sliding out of position, place it on the crawler frame, and connect it to the circuit using the red & black jumper wires.

Turn on the slide switch (S1), and then use the switcher (S6) to make the crawler go forward, backward, or stop. You can follow the crawler around the room or table carrying the base grid while using S6 to control it. Be careful to follow it closely so you don't over-extend the jumper wires, and to keep it from falling off the table. The crawler does not turn.



Project 32 Crawler with Control Light

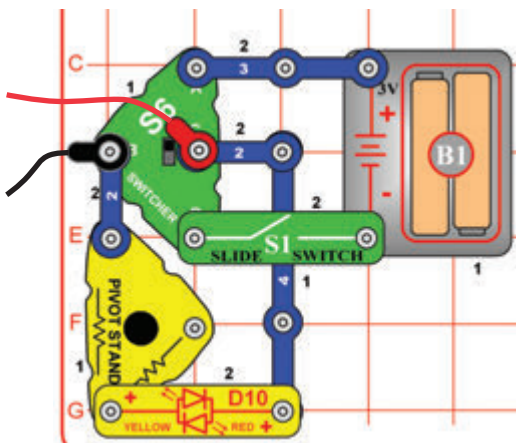

Modify the preceding circuit to include the red/yellow bicolour LED (D10), which lights yellow when the crawler is going forward, or red with it goes backward.



Project 33

High Speed Crawler

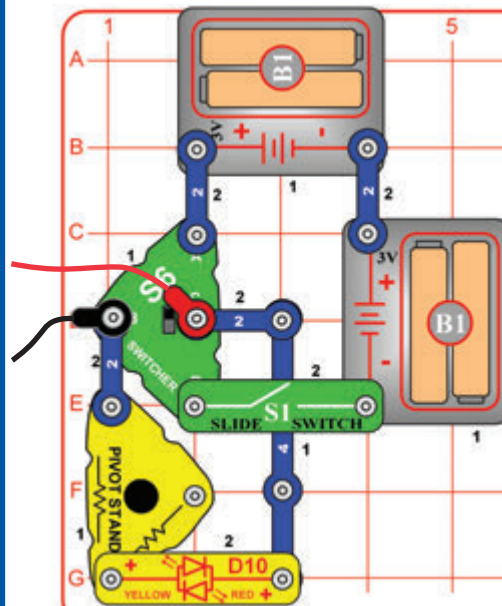

Modify the preceding circuit to use a second battery holder (B1), as shown. The crawler is much faster now.

Project 34 Crawler with On-Board Control

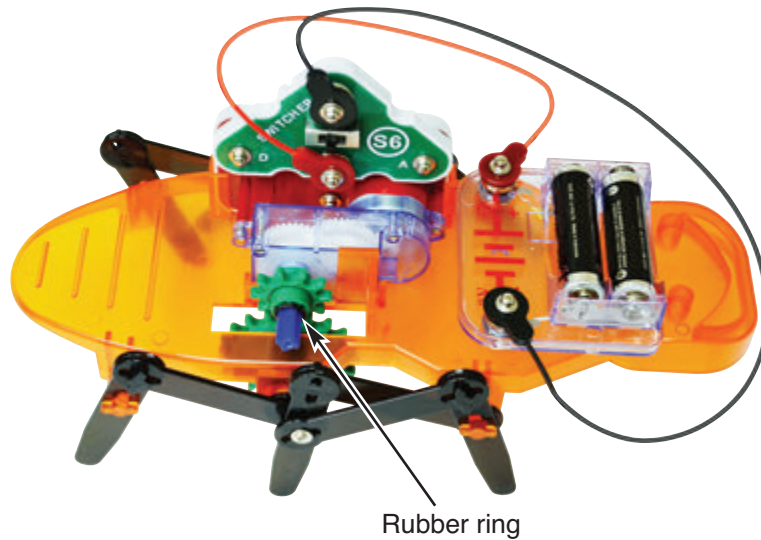

Assemble the crawler using the assembly instructions on pages 6 and 7, and build the circuit shown here. Mount the smallest gear (1.0") on the geared motor (GM) with a rubber ring to keep it from sliding out of position. Place it on the crawler frame, place the switcher (S6) directly on the geared motor, set S6 to the middle position, place a battery holder (B1) on the front of the crawler frame, connect the red jumper wire from + on B1 to C on S6, then connect black wire from - on B1 to B on S6. Be sure the jumper wires will not interfere with the gears or legs. Be careful that the crawler does not fall off a table or down a stairway! The crawler does not turn.

Set S6 to the "A" side to make the crawler go forward, or set it to the "D" side to make the crawler go backwards.

Project 35 Crawler with Light

Add the color LED (D8) directly on top of the jumper wire connections to the battery holder (B1, LED + to battery +). Alternately, you can use the red/yellow bicolor LED (D10), oriented in either direction.

Remove the LED when you are finished. Note that normally connecting an LED directly to a battery can damage the LED, but the color LED has an internal resistor that will protect it.

Project 36

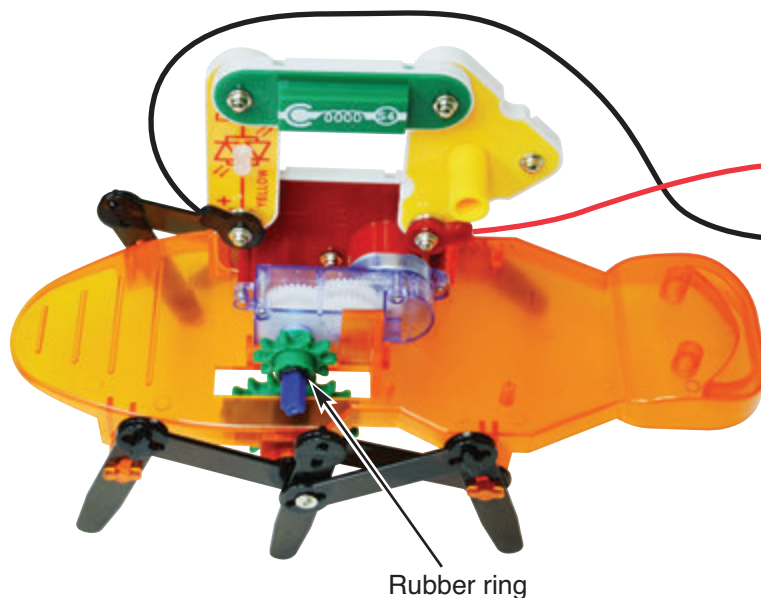

Crawler with Motion Light

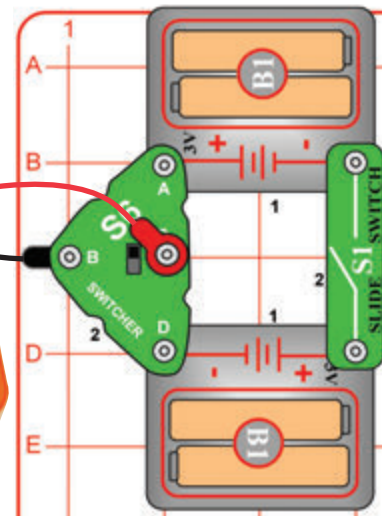

Assemble the crawler using the assembly instructions on pages 6 and 7, and build the circuit shown here. Mount the smallest gear (1.0") on the geared motor (GM) with a rubber ring to keep it from sliding out of position, and place it on the crawler frame. Mount the red/yellow bicolor LED (D10), vibration switch (S4), and pivot stand to the geared motor in the arrangement shown, and connect to the circuit on the base grid using the red & black jumper wires as shown.

Turn on the slide switch (S1), and then use the switcher (S6) to make the crawler go forward, backward, or stop. When the crawler is moving, vibrations will often light the red/yellow LED. You can follow the crawler around the room or table carrying the base grid while using S6 to control it. Be careful to follow it closely so you don't over-extend the jumper wires, and to keep it from falling off the table. The crawler does not turn.



Project 37

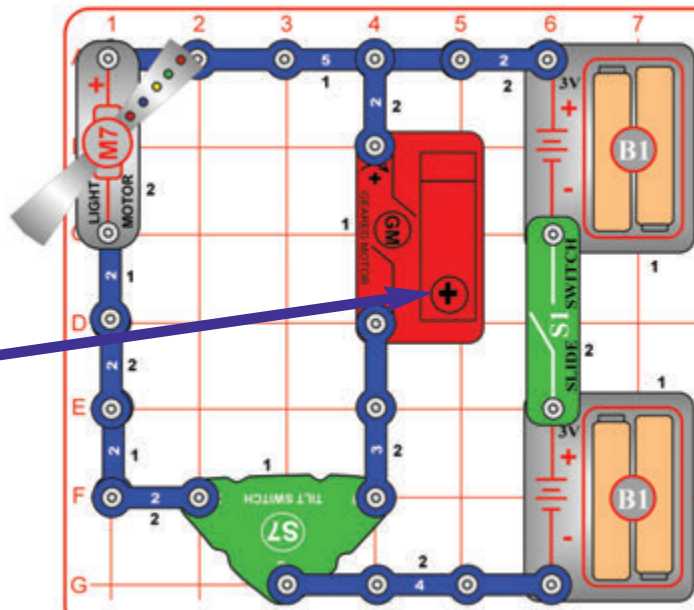
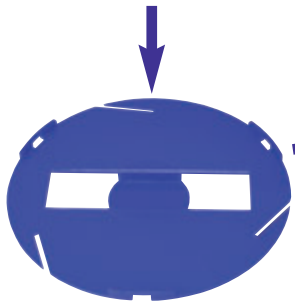

Tilt Motion

Assemble the circuit and mount the merry-go-round base on the geared motor (GM) shaft. Place cardboard figures on the merry-go-round if desired.

Turn on the slide switch (S1). The merry-go-round or light motor start if the circuit is tilted or moved. Experiment to see which tilt angles activate which effects.

If the circuit does not shut off when left alone, then tilt it slightly so it turns off.

WARNING: Moving parts. Do not touch the fan during operation.



Project 38

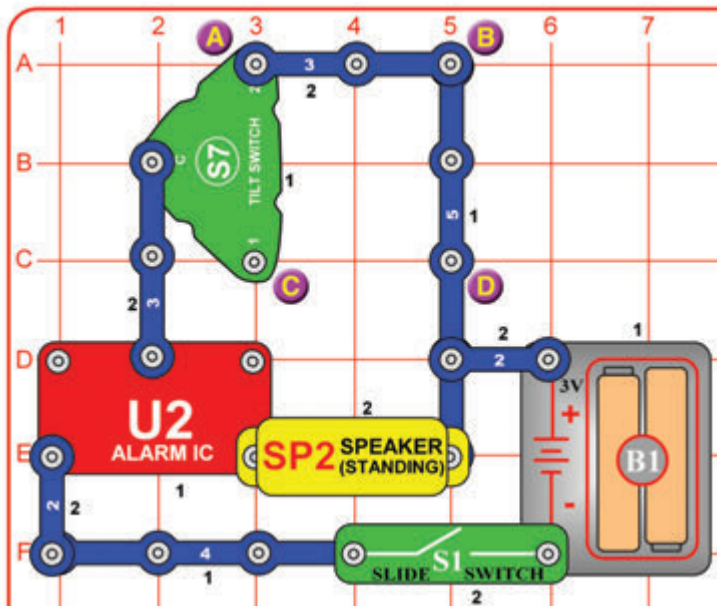

Tilt Alarm

Build the circuit and turn on the slide switch (S1). An alarm sounds if the circuit is moved, or tilted in some directions.

If the circuit does not shut off when left alone on a flat surface, then tilt it slightly so it turns off.

Next, move the 3-snap wire from the points marked A & B to the points marked C & D. Now it is sensitive to tilt in different directions.

If you place 3-snap wires across A & B, and C & D, then the circuit will be so sensitive to tilt that the alarm may be difficult to shut off.



Project 39

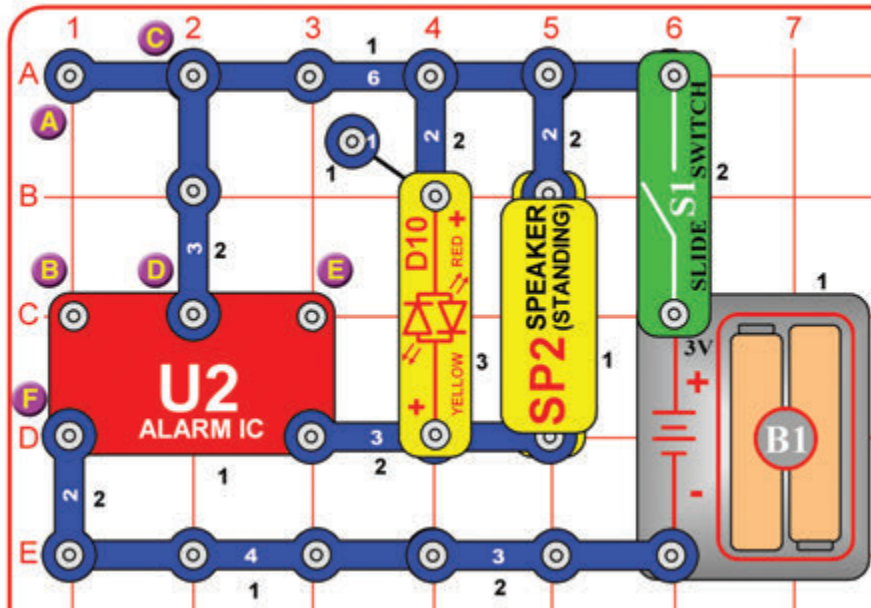

Alarm Sounds & Lights

Build the circuit and turn on the slide switch (S1). An alarm sounds and a light comes on.

Add a connection between the points marked D & E using a 1-snap and a 2-snap. Now it sounds like a machine gun.

Remove the connection between D & E, and add a connection between B & D. Now it sounds like a fire engine.

Remove the connection between B & D, and add a connection between B & F. Now it sounds like a European siren.

Remove the connections between B & F and C & D, and add a connection between A & B. See what it sounds like now.



Project 40 Softer Alarms

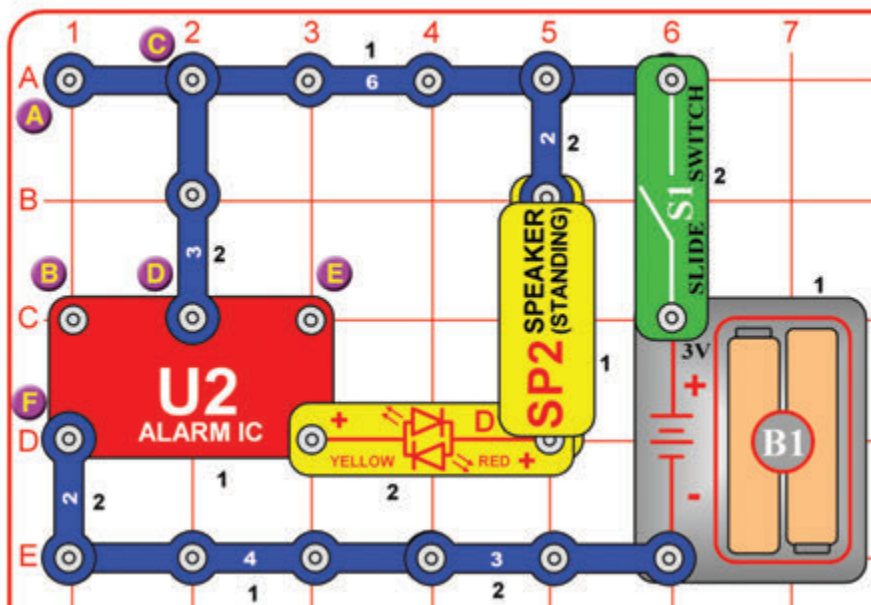

Modify the preceding circuit to be this one. It works the same way, except that it isn't as loud. Try the same variants as for the preceding circuit.



Project 41 Funky Colors Alarms

Use the preceding circuit, but replace the red/yellow bicolor LED (D10) with the color LED (D8, "+" on right). Try all the same variants as for the preceding two circuits. You should see some interesting effects in the color LED's colors.



Project 42

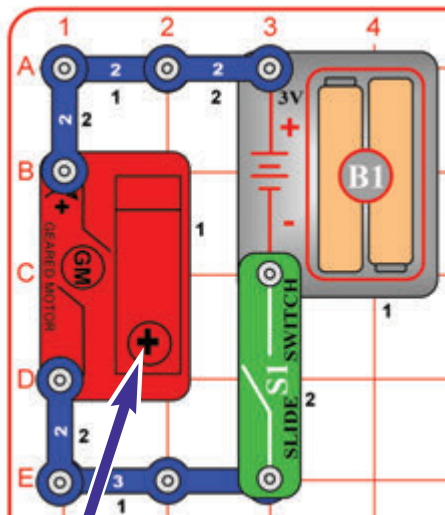

Lighthouse

Build this circuit and mount the merry-go-round base onto the shaft on the geared motor (GM). Next, place the color LED (D8) directly across the snaps on the other battery holder (B1) as shown; the color LED starts flashing. Now place that battery holder into the slot in the merry-go-round base. Turn on the slide switch (S1), and the color LED spins, shining its light around the room like a lighthouse! For best effects, turn off or dim the room lights.

Disconnect the color LED from the battery holder when you are finished, to avoid draining your batteries.

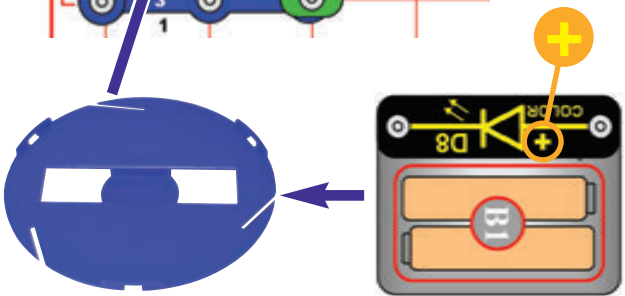

Normally connecting an LED directly to a battery can damage the LED, but the LEDs in this set (D8 & D10) have internal resistors to protect them from incorrect wiring, and will not be damaged.



Project 43 Merry-Go-Round



Use the preceding circuit, but insert some of the cardboard figures into the 3 slots on the edge of the merry-go-round base (the figures may need to be punched out of a cardboard sheet).

You may also mount the color LED (D8) in the other battery holder (B1) as done in the preceding circuit, to have a light in the merry-go-round.

Project 44 Fast Merry-Go-Round

Use the preceding circuit, but replace the 3-snap wire with the second battery holder (B1). Now the merry-go-round spins faster.



Project 45

Merry-Go-Round with Music & Light

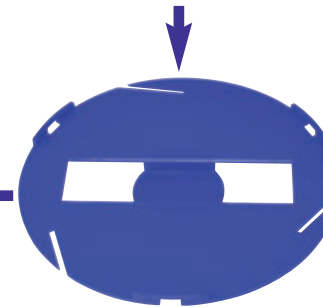
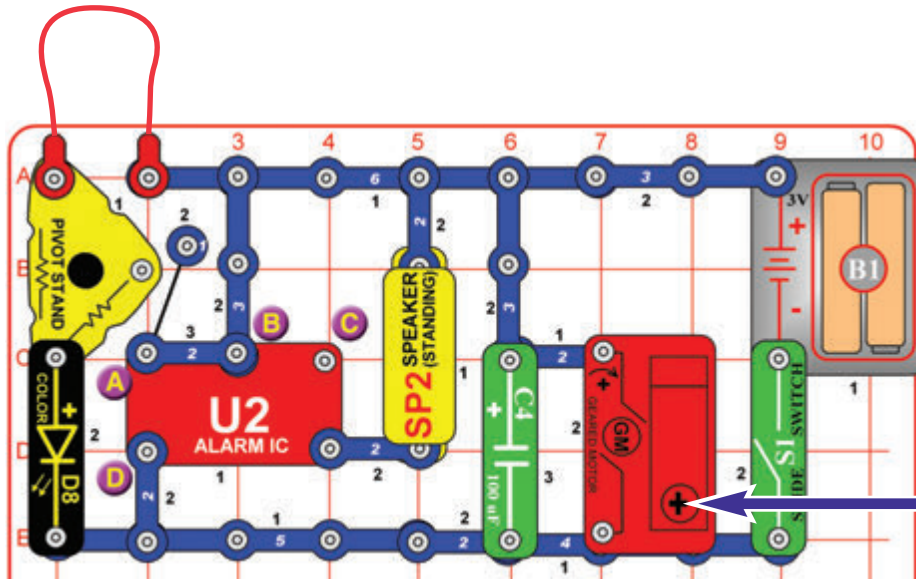

Insert some of the cardboard figures into the 3 slots on the edge of the merry-go-round base (the figures may need to be punched out of a cardboard sheet). Build this circuit and mount the merry-go-round base onto the shaft on the geared motor (GM).

Turn on the slide switch (S1) and watch the show!

You can change the sound by removing the 1-snap and 2-snap wires that are at point A, or by moving them to be across points B & C, or across points A & D.



Project 46

Fast Merry-Go-Round with Music & Light

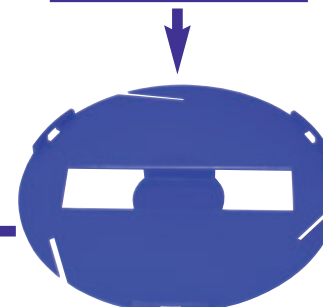
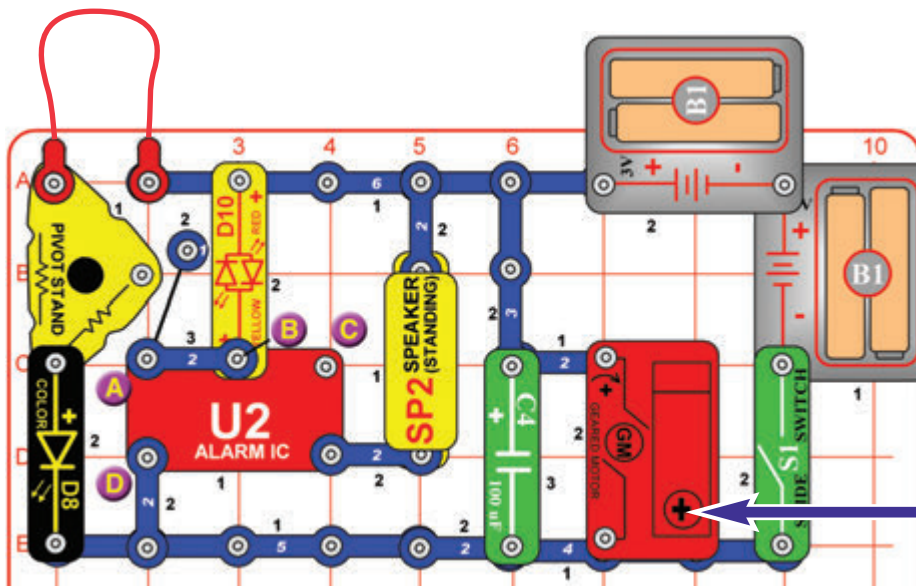

Insert some of the cardboard figures into the 3 slots on the edge of the merry-go-round base (the figures may need to be punched out of a cardboard sheet). Build this circuit and mount the merry-go-round base onto the shaft on the geared motor (GM).

Turn on the slide switch (S1) and watch the show!

You can change the sound by removing the 1-snap and 2-snap wires that are at point A, or by moving them to be across points B & C, or across points A & D.

Project 47 Hypnotic Discs

Use the preceding circuit (Fast Merry-Go-Round with Music & Light), but remove the cardboard figures from the merry-go-round base and install one of the colored discs into the base. Watch the hypnotic patterns on the discs as they spin.

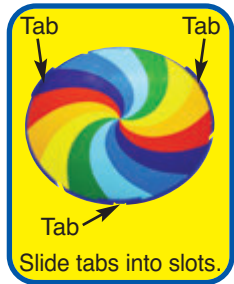

Project 48 Strobe Light with Music

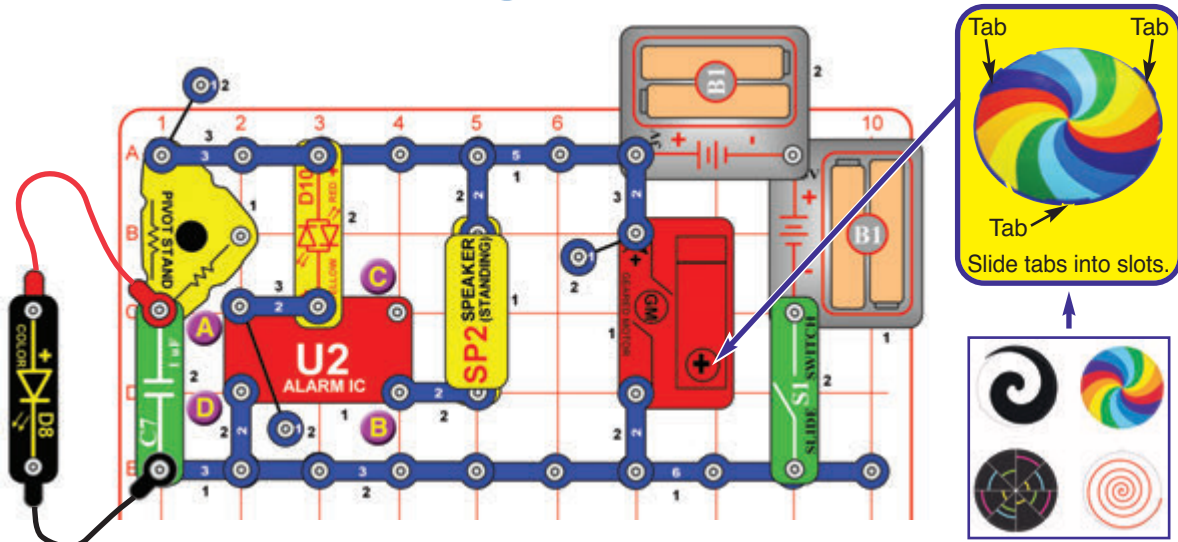

Here are some effects to watch for:

With this disc, the white lines are often visible despite spinning so fast, and some colors sometimes seem to disappear.

When red flashes on the LED, the red spiral pattern can seem hypnotizing.



With this disc, some colors seem to disappear at times.

This pattern can seem hypnotizing.



Modify the preceding circuit to be this one; which has the color LED (D8) connected with the red & black jumper wires, and the 1µF capacitor (C7) placed where the color LED had been. Install one of the colored discs into the merry-go-round base.

For best effects, do this in a dimly lit room. Turn on the slide switch (S1). Hold the color LED upside down over the merry-go-round base so it shines on the spinning disc.

Observe the effects as the color LED flashes on the disc as it spins. Try it with different discs.

Variants: You can change the sound by removing the 1-snap and 2-snap wires that are at point A, or by moving them to be across points B & C, or across points A & D.

If the color LED flash rate is synchronized with the disc rotation speed, it can appear to "freeze" parts of the spinning disc pattern. Also, as different colors flash, those colors can seem to disappear.

More about this in project 54, which uses gears to spin the disc faster and has adjustable speed, but does not have music.

The 1µF capacitor is used to filter the voltage to the color LED. Without it, electrical disturbances from the speaker and geared motor would disrupt the color LED's flashing pattern.





Project 49

Slow Merry-Go-Round

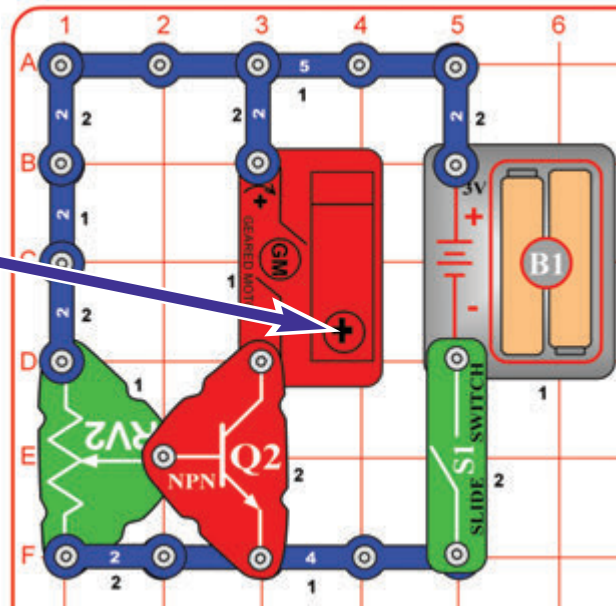
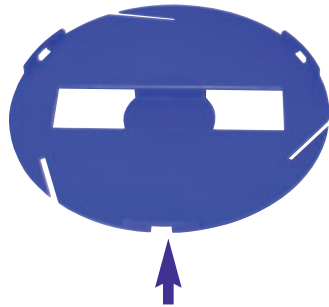

Insert some of the cardboard figures into the 3 slots on the edge of the merry-go-round base (the figures may need to be punched out of a cardboard sheet). Build this circuit and mount the merry-go-round base onto the shaft on the geared motor (GM).

Turn on the slide switch (S1), and adjust the speed of the merry-go-round using the lever on the adjustable resistor (RV2). Most of the speed control will be over a small part of RV2's adjustment range.



Project 50

Adjustable Merry-Go-Round with Lights

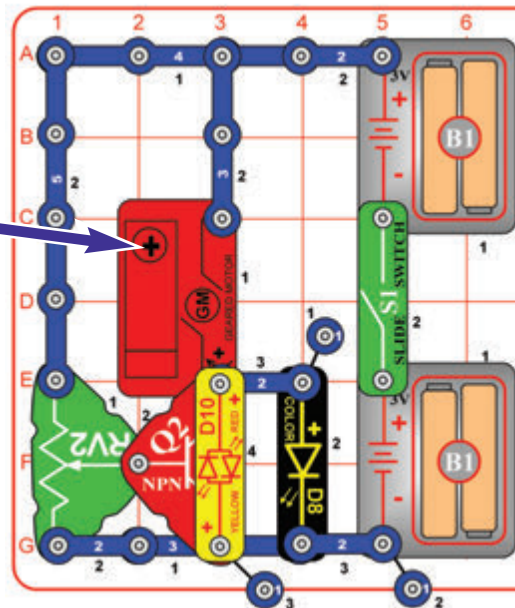
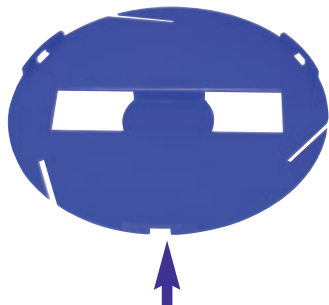

Modify the preceding circuit to make this one. Set the lever on the adjustable resistor (RV2) to the top. Turn on the slide switch (S1), and use the lever on the adjustable resistor to set the brightness of the LEDs (D8 & D10) and the speed of the merry-go-round base.

This circuit uses the NPN transistor (Q2) and adjustable resistor (RV2) to control the speed of the geared motor (GM). A small electric current into the transistor through RV2 and the LED (D10) controls a larger current into the transistor through the geared motor. RV2 cannot be used to control the geared motor directly, because its high resistance would prevent the geared motor from operating.

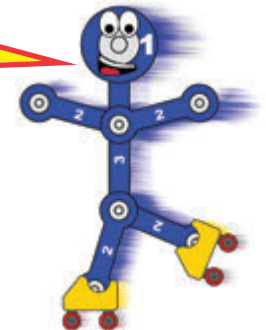



Project 51

If gear slides down "+" shaft during use then add a rubber ring to keep it in place. ○

Ledge must be on bottom side

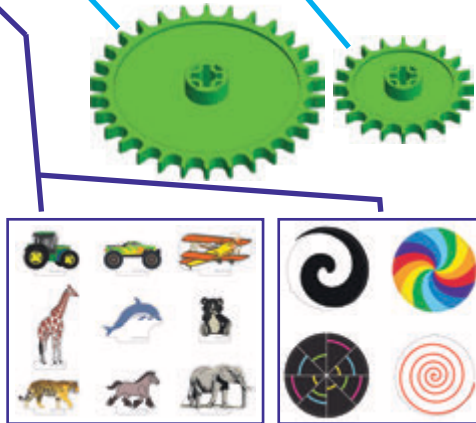
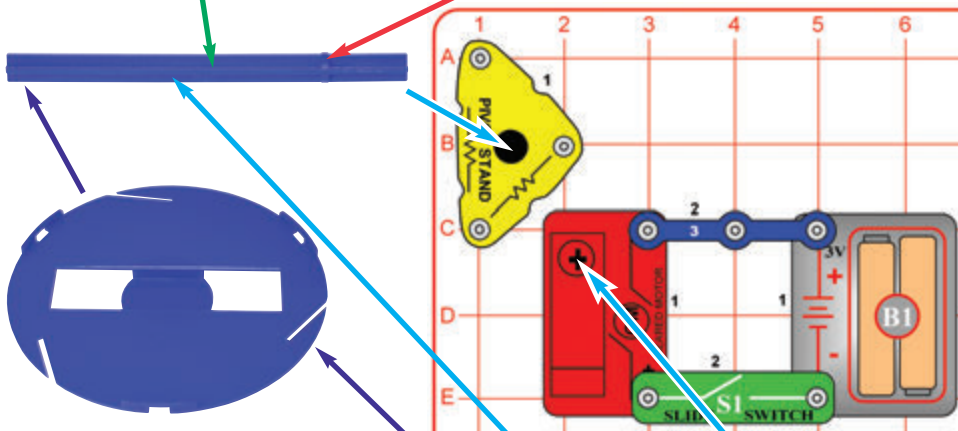

Fun with Gears

Build the circuit shown. Mount the 1.75" gear on the geared motor (GM), mount the 2.55" gear on the "+" shaped bar, place the "+" bar into the pivot stand, and then align the position of the 2.55" gear on the "+" shaft so the teeth of both gears mesh. Either insert some of the cardboard figures into the 3 slots on the edge of the merry-go-round base, or install one of the colored discs into the base. Mount the merry-go-round base onto the top of the "+" shaped bar.

Turn on the slide switch (S1), and notice how fast the merry-go-round (or disc) is spinning. If the gear slides down the "+" bar during use then add a rubber ring to keep it in place.

Part B: Swap the positions of the 1.75" and 2.55" gears, so that the larger gear is on the geared motor and the smaller one is on the "+" shaped bar. Notice how much faster the merry-go-round is spinning now. Compare the size difference between the gears to how much faster one is spinning.

Part C: Remove the pivot stand and mount the merry-go-round base directly on the geared motor. Compare the speed to how it was when using the gears.

Part D: Try replacing the 3-snap wire with a second battery holder (B1). This can be done with any of the above gear arrangements. The additional battery voltage makes things spin faster.

Gears can be used to make things spin faster or slower. When one gear has more teeth than another, it will spin slower. Using gears to reduce rotation speed also increases the turning force, allowing it to overcome more friction. Using gears also changes the direction of rotation.

Inside the geared motor (GM) is a motor spinning very fast, but with little force (much too little to spin the merry-go-round). Several small gears connect the motor to the white "+" shaped shaft; these reduce the rotation speed, giving the shaft enough force to spin the merry-go-round, and also making it easier to control.



Project 52

Higher Gear Ratio

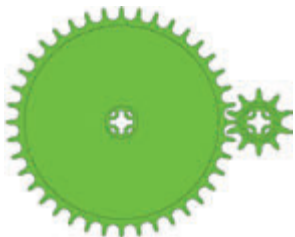

Use the preceding circuit, but replace the 1.75" and 2.55" gears with the 1.0" (smallest) and 3.3" (largest) gears. Try it both ways:

Part A: With the smallest gear on the geared motor and the largest gear on the pivot stand, the merry-go-round (or disc) should spin very slow. Compare the size difference between the gears to how much faster one is spinning.

Part B: With the largest gear on the geared motor and the smallest gear on the pivot stand, the merry-go-round (or disc) should spin very fast.

Note: You cannot use the 1.0" or 3.3" gears with the 1.75" or 2.55" gears, because you cannot get the proper spacing needed for their teeth to mesh well enough.



Project 53

Spin Draw

Use either of the preceding two circuits, with any of the described gear combinations. Cut a piece of white paper to the same size as one of our discs, or use the back of our discs. Put them in the merry-go-round base and spin it.

Take a soft marker and GENTLY touch it on the spinning disc. Move it around to draw patterns on the disc. Try starting in the middle and slowly moving your marker outward. Be careful not to use too much force or you could damage your parts.



Project 54

Strobe Light

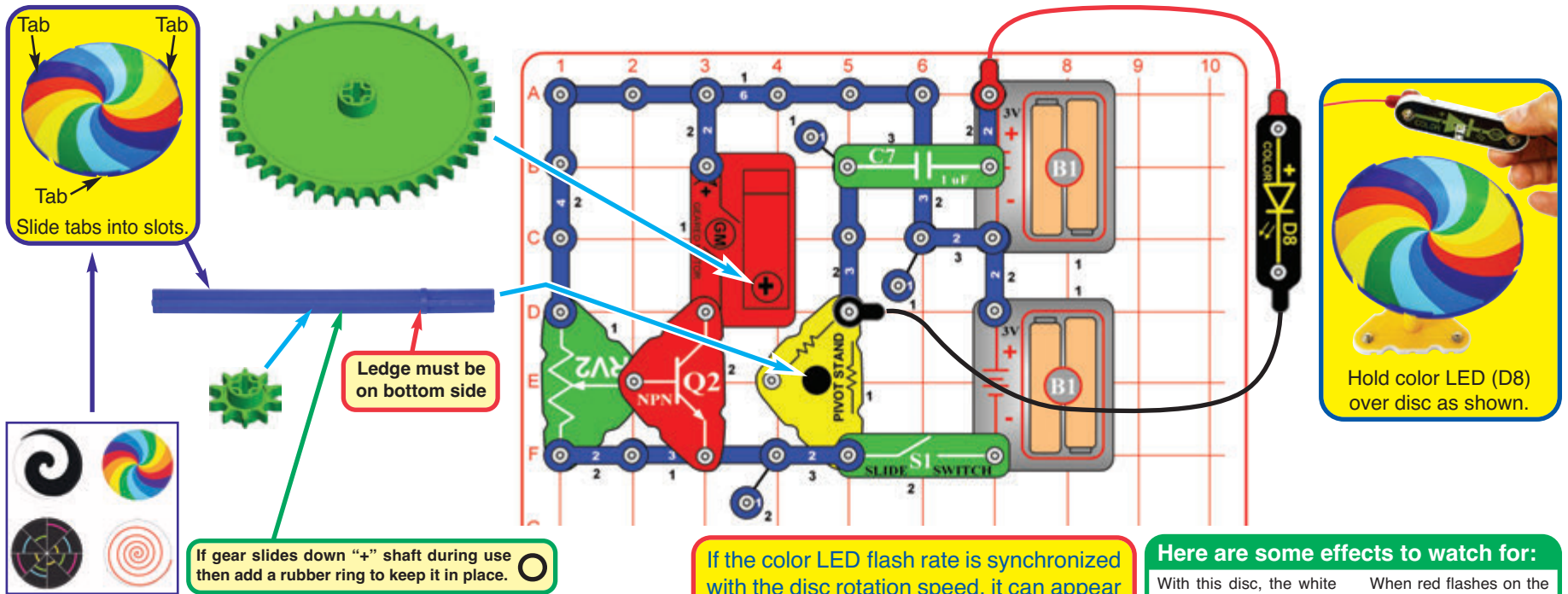

Build the circuit shown. Mount the 3.3" gear on the geared motor (GM), mount the 1.0" gear on the "+" shaped bar, place the "+" bar into the pivot stand, and then align the position of the 1.0" gear on the "+" shaft so the teeth of both gears mesh. Install one of the colored discs into the merry-go-round base. Mount the merry-go-round base onto the top of the "+" shaped bar. Connect the color LED (D8) using the red & black jumper wires.

For best effects, do this in a dimly lit room. Turn on the slide switch (S1). Hold the color LED upside down over the merry-go-round base so it shines on the spinning disc. Vary the spin speed using the lever on the adjustable resistor (RV2). If the gear slides down the "+" bar during use then add a rubber ring to keep it in place.

Observe the effects as the color LED flashes on the disc as it spins. Try it with different discs.

If desired, you can replace the 1.0" gear with the 1.75" gear, and replace the 3.3" gear with the 2.55" gear. The disc will spin more slowly now.

If the color LED flash rate is synchronized with the disc rotation speed, it can appear to "freeze" parts of the spinning disc pattern. Also, as different colors flash, those colors can seem to disappear.

The 1µF capacitor is used to filter the voltage to the color LED. Without it, electrical disturbances from the speaker and geared motor would disrupt the color LED's flashing pattern.



Here are some effects to watch for:

With this disc, the white lines are often visible despite spinning so fast, and some colors sometimes seem to disappear.

When red flashes on the LED, the red spiral pattern seems to disappear. This pattern can seem hypnotizing.

With this disc, some colors seem to disappear at times.

This pattern can seem hypnotizing.

Project 55

Make Your Own Patterns

Draw your own patterns on paper or cardboard, then cut them to the same size as our discs. You can also draw patterns on the backs of our discs. Put them in the merry-go-round base and repeat the preceding project. Have a contest with your friends to see who can make the most interesting hypnotic or strobe effects! You can also find lots of fun patterns and visual illusions by doing a search on the internet.

Project 56

Fun with Pulleys

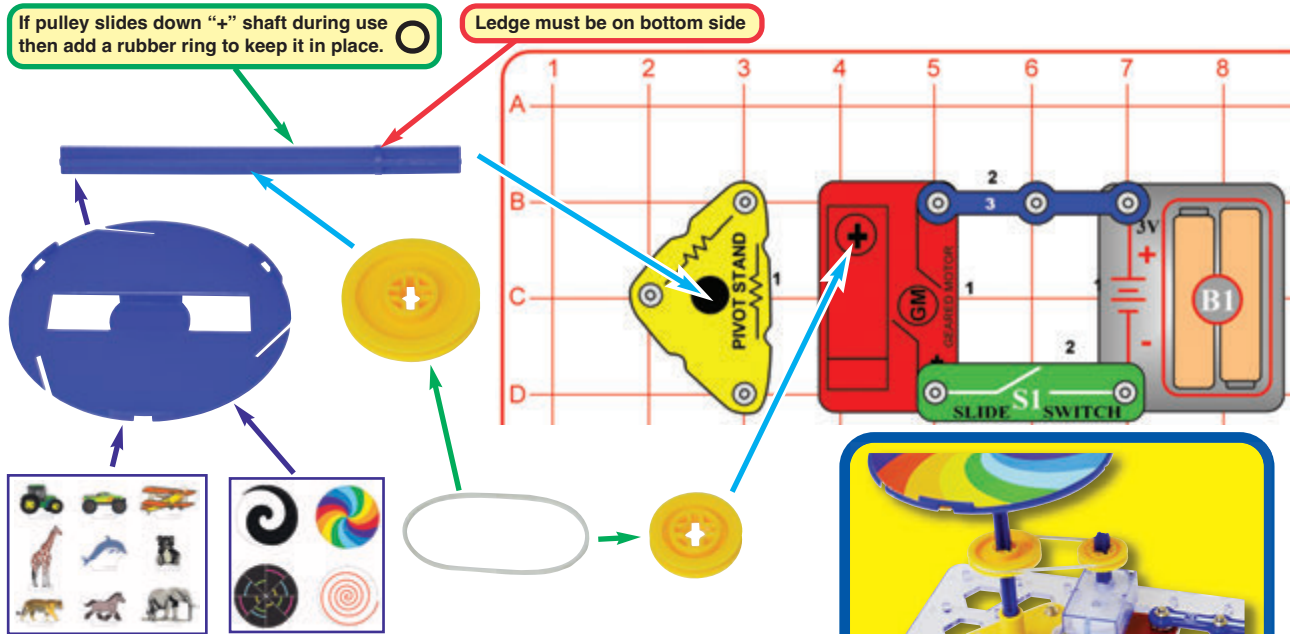

Build the circuit shown. Mount the 0.9" pulley on the geared motor (GM), mount the 1.3" pulley on the "+" shaped bar, place the "+" bar into the pivot stand, and then align the position of the 1.3" pulley on the "+" shaft so it is the same height as the 0.9" pulley. Place the rubber band around both pulleys. Either insert some of the cardboard figures into the 3 slots on the edge of the merry-go-round base, or install one of the colored discs into the base. Mount the merry-go-round base onto the top of the "+" shaped bar.

Turn on the slide switch (S1), and notice how fast the merry-go-round (or disc) is spinning. If the pulley slides down the "+" bar during use then add a rubber ring to keep it in place.

Part B: Swap the positions of the 0.9" and 1.3" pulleys, so that the larger pulley is on the geared motor and the smaller one is on the "+" shaped bar. Notice how much faster the merry-go-round is spinning now. Compare the size difference between the pulleys to how much faster one is spinning.

Part C: Remove the pivot stand and mount the merry-go-round base directly on the geared motor. Compare the speed to how it was when using the pulleys.

Part D: Try replacing the 3-snap wire with a second battery holder (B1). This can be done with any of the above gear arrangements. The additional battery voltage makes things spin faster.

Part E: Replace the rubber band with one from your home, and change the location of the pivot stand on the base grid so there is tension in your rubber band. Don't make the band too tight, because then the snaps on the pivot stand may not be able to hold it in place. Turn on the circuit and see how well it works.

Note: If the pivot stand comes off the base grid due to the tension of the rubber band, see the next project for help.

Pulleys can be used to make things spin faster or slower. When one pulley is larger than another, it will spin slower. Using pulleys to reduce rotation speed also increases the turning force, allowing it to overcome more friction.

Pulley transfer power across small distances, because the pulleys are separated by a small gap, such as that between the geared motor and pivot stand here.

It is important to have the proper tension in the rubber band (or other material) attached between the pulleys. If there is too much tension, energy is lost and there is too much strain on the shafts and band, so these soon break. If there too little tension in the band, the band may start slipping or fall off. The bands used with pulleys are typically made of durable materials like nylon.





Project 57

If pulley slides down "+" shaft during use then add a rubber ring to keep it in place. 

Ledge must be on bottom side

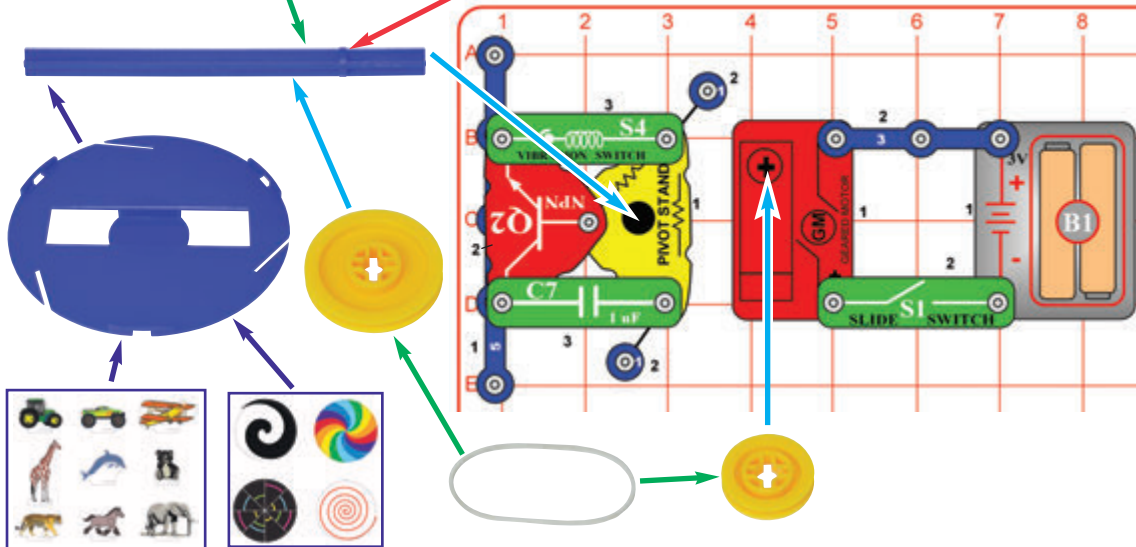

Secure Pulley

In the preceding project, tension in the rubber band pulls on the "+" shaped bar and pivot stand, and may pull the pivot stand snaps off the base grid. If so, modify the circuit to be the one shown here, which uses additional parts (S4, Q2, and C7) to help hold and secure the pivot stand in place. In part E, when repositioning the pivot stand to use your own rubber band, you can reposition S4, Q2, and C7 to help hold the pivot stand in its new location.

This circuit is electrically the same as the preceding one. Parts S4, Q2, and C7 are only used to help hold the pivot stand in place, and have no electrical function.



Project 58 More Pulleys



Repeat projects 56/57, but replace each of the pulleys with the larger 2.1" pulley. Try this both with the 2.1" pulley on the pivot stand, and then with it in the geared motor. Also try it with your own rubber band, as described in Part E of project 48.



With the large 2.1" pulley on the pivot stand and the small 0.9" pulley on the geared motor, the merry-go-round (or disc) spins very fast. With the small 0.9" pulley on the pivot stand and the large 2.1" pulley on the geared motor, the merry-go-round (or disc) spins very slow.



Project 59

Trip-Wire Lights

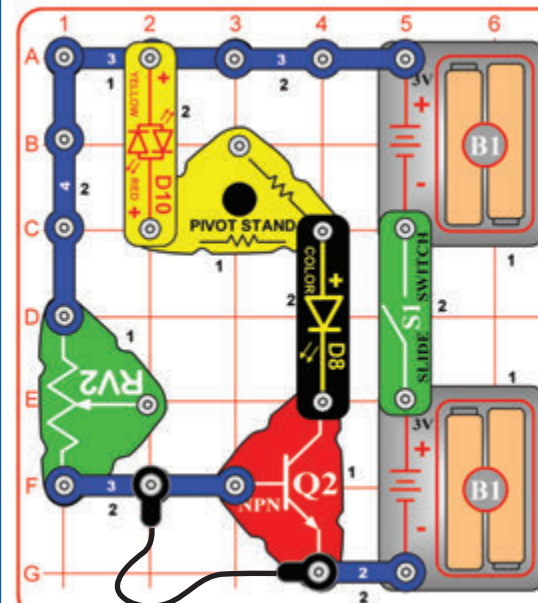

Build the circuit shown and turn on the slide switch (S1). Nothing happens. Break the black jumper wire connection and lights flash. You could replace the black jumper wire with a longer wire and run it across a doorway to signal an alarm when someone enters.

You can reverse the red/yellow bicolor LED (D10) to change its color. The adjustable resistor (RV2) is used here as a fixed resistor, so moving its lever won't do anything.



Project 60

Triple Lights Motion

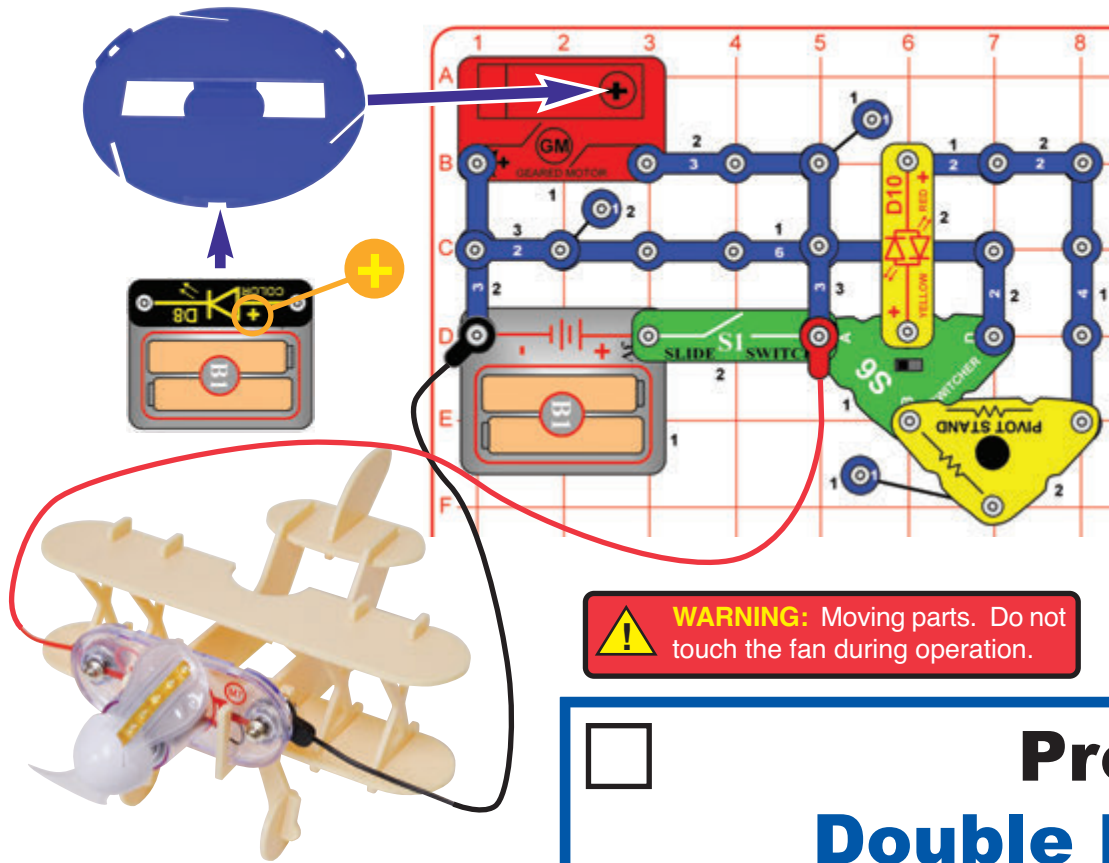

Assemble the airplane using the instructions on page 5, install the light motor (M7) into the front of it, build the circuit shown here, and connect the red & black jumper wires to the light motor (red to “+”). Place the airplane on a smooth surface and spread out the jumper wires and be sure they will not interfere with the fan on the light motor.

Mount the merry-go-round base onto the shaft on the geared motor (GM). Next, place the color LED (D8) directly across the snaps on the other battery holder (B1) as shown; the color LED starts flashing. Now place that battery holder into the slot in the merry-go-round base. Turn on the slide switch (S1).

The color LED spins, shining its light around the room like a lighthouse. The fan on the light motor spins and lights dimly, and the airplane slowly moves around due to vibration. Move the switcher (S6) switch back and forth to make the red/yellow bicolor LED (D10) change colors.

Disconnect the color LED from the battery holder when you are finished, to avoid draining your batteries.



Project 61

Double Lights Motion

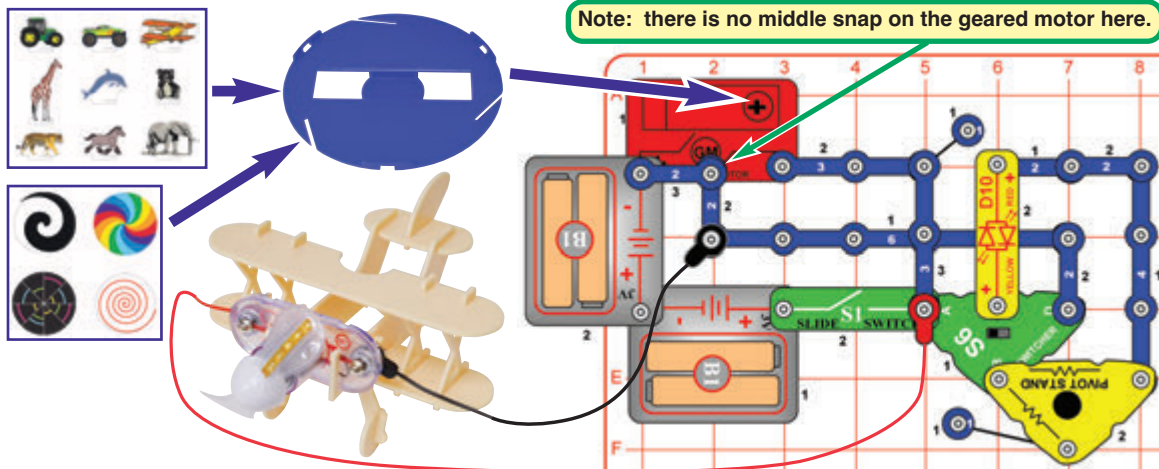

Modify the preceding circuit by removing the color LED (D8) and adding the second battery holder (B1) to the circuit as shown. Either insert some of the cardboard figures into the 3 slots on the edge of the merry-go-round base, or install one of the colored discs into the base. Mount the merry-go-round base onto the shaft on the geared motor (GM). Turn on the slide switch (S1).

The fan on the light motor spins and lights, and the airplane slowly moves around due to vibration. Move the switcher (S6) back and forth to make the red/yellow bicolor LED (D10) change colors.



Project 62

WARNING: Moving parts. Do not touch the fan during operation.

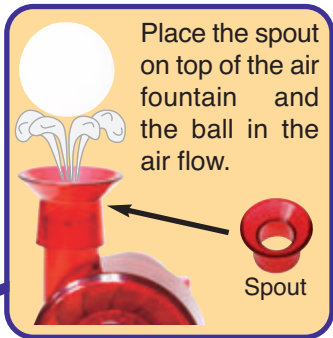
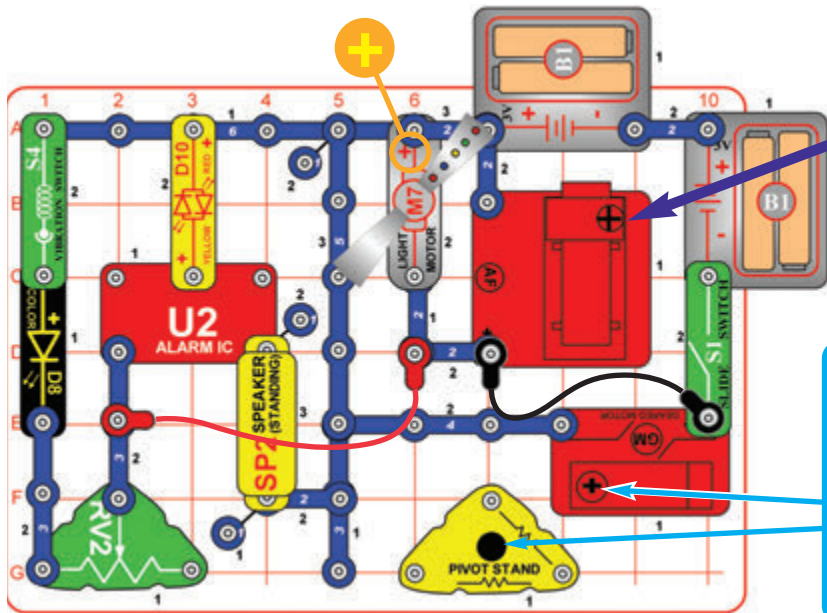

Mount a green gear on the geared motor, a matching gear and the on the "+" shaped bar, place the bar in the pivot stand and align the gears, place a colored disc or figures on the merry-go-round base and mount it on the "+" bar. If gear slides down shaft during use then add a rubber ring to keep it in place.

Big Circuit

Build the circuit as shown. Place the spout and ball on the air fountain (AF). Place one of the green gears on the geared motor (GM). Mount a matching green gear on the "+" shaped bar with a rubber ring to keep it in position, place the bar in the pivot stand, and adjust the position of the green gear on it to interlock with the gear on the geared motor. Place a colored disc or some of the figures on the merry-go-round base and mount the base on the "+" shaped bar. Be sure that the red & black jumper wires will not touch the fan on the light motor (M7), the gears, or the merry-go-round.

Turn on the slide switch (S1) and watch the show! The air fountain will propel the ball into the air but it may be unstable and fall off quickly. Set the lever on the adjustable resistor (RV2) to the left and tap on the vibration switch (S4) to make the color LED (D8) flash. The tilt switch (S7) is used here as a 1-snap, and won't activate anything.

NOTE: this circuit may work for a while and then suddenly shut down. If so, turn off the slide switch, wait a little while, and then turn it back on. See Snappy's comments in project 66 for an explanation.



Project 63

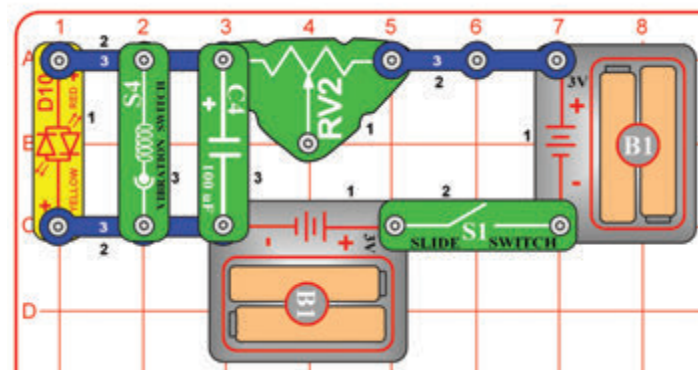

The vibration switch (S4) is connected so it bypasses the red/yellow bicolor LED (D10), so whenever vibrations turn on the switch, the LED turns off. However the vibrations occur so fast, turning off the LED so briefly that normally your eyes wouldn't even notice. The 1µF capacitor (C7) is used here to slow things down, so the LED does not immediately come back on after the vibration switch turned it off. If you remove C7, then you probably won't notice vibrations shutting off the LED (try it).

Vib Off

Build the circuit as shown and turn on the slide switch (S1). The red/yellow bicolor LED (D10) should be on. Tap on the vibration switch (S4) or bang on the table to make the LED blink (indicating that it is turning off briefly).

The adjustable resistor (RV2) is used here as a fixed resistor, so moving its lever won't do anything.

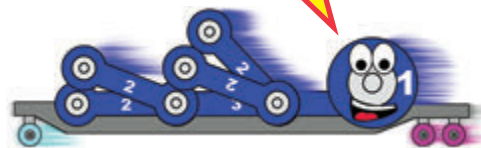



Project 64

Audio Triple Detector

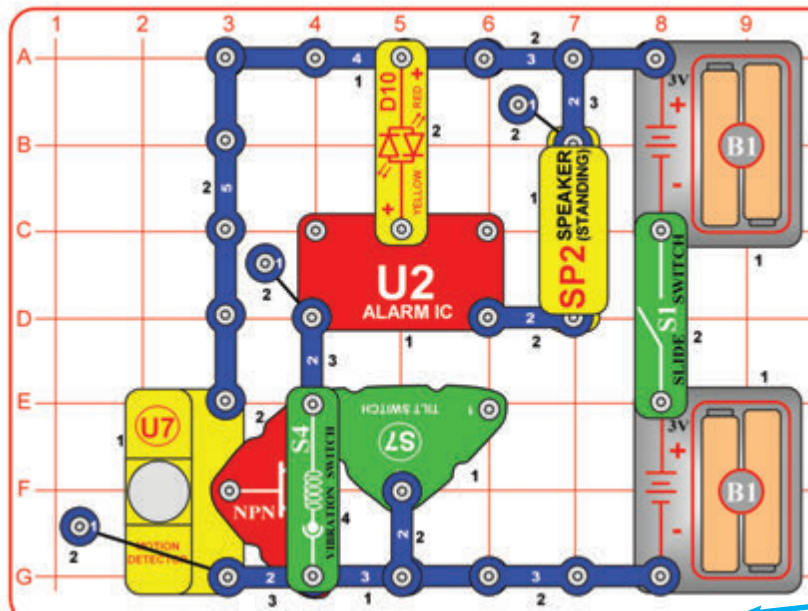

Assemble the circuit and place the base grid into the blue stand (with the NPN transistor (Q2) closest to the stand) and carefully stand it up. Position it near the edge of a table, facing across a room.

Turn on the slide switch (S1). An alarm sounds for a few seconds on start-up, and then whenever the circuit detects motion, detects vibration, or is tilted in some directions.

This circuit will work in the dark, but be careful not to hurt yourself moving around a room in the dark.



This circuit could be used as a security system. It lights if it detects someone moving across the room, and sounds an alarm if someone tries to move the circuit out of their path.

Mount circuit on the blue stand and face across a room.



Project 65

Vibration Plane

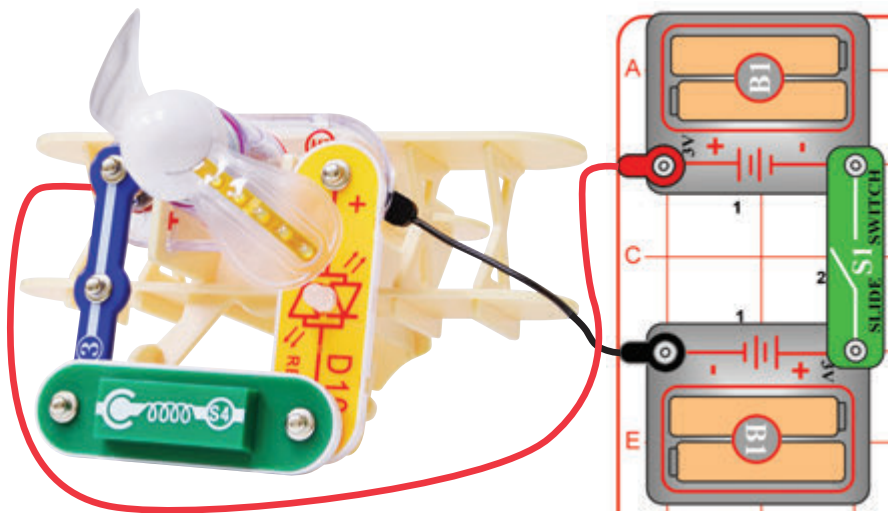

Note: This circuit has the red/yellow bicolor LED (D10) connected directly across the batteries without another component to limit the current. Normally this might damage the LED, however Boffin LEDs have internal protection resistors to protect them from incorrect wiring, and will not be damaged.

Assemble the airplane using the instructions on page 5, install the light motor (M7) into the front of it, then connect the other part to it (while it is mounted on the airplane), as shown. Spread out the jumper wires and be sure they will not interfere with the fan on the light motor.

Place the airplane on a smooth surface and turn on the slide switch (S1). The fan on the light motor spins and lights, and the airplane slowly moves around due to vibration. The red/yellow bicolor LED (D10) also lights red, because it is connected in series with the vibration switch (S4), which is triggered by the vibrations.

Now take the airplane off the table and hold it in the air, or place it on carpet. The red/yellow may not light now because the vibrations are cushioned, and may not be enough to trigger the vibration switch.



WARNING: Moving parts. Do not touch the fan during operation.



Project 66

Too Much at Once?

Mount the medium-small green gear on the geared motor, the medium-large gear and the on the "+" shaped bar, place the bar in the pivot stand and align the gears, place a colored disc or figures on the merry-go-round base and mount it on the "+" bar. If gear slides down shaft during use then add a rubber ring to keep it in place.

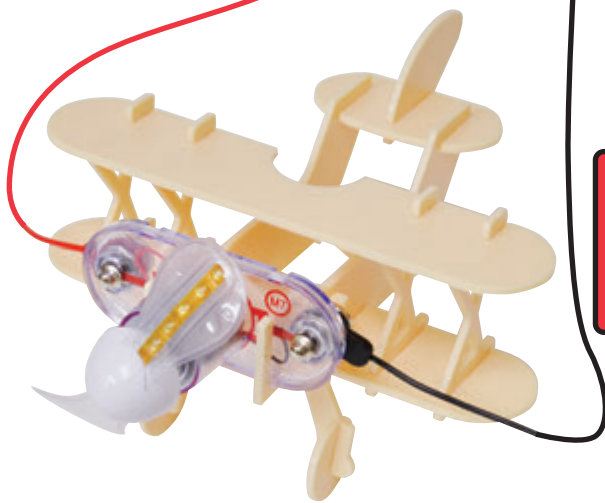
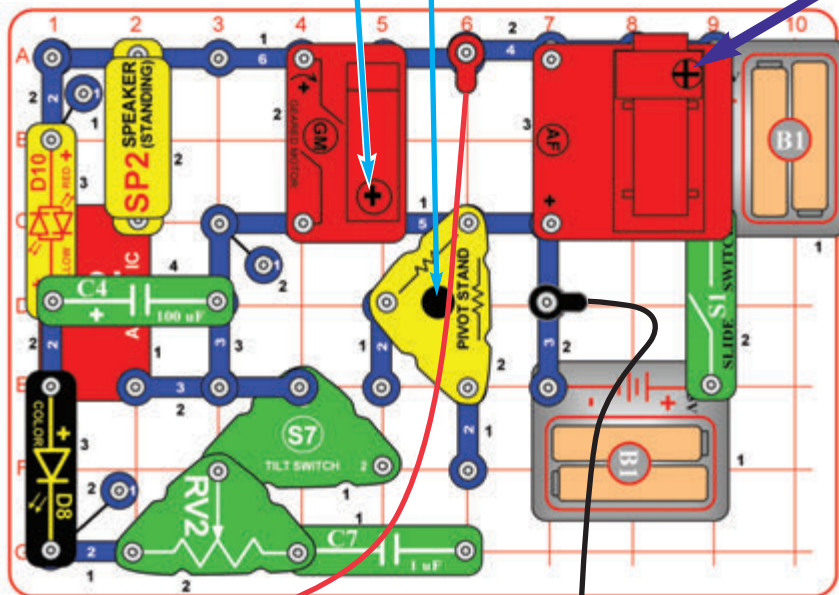

WARNING:
Moving parts. Do not touch the fan during operation.

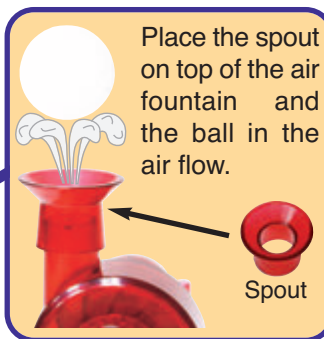

The battery holders (B1) include a special fuse which activates if the current is too high. Usually this fuse will only activate when there is a short circuit, but sustained high circuit currents can sometimes activate it. If the conditions that activated the fuse are removed, then the fuse resets after a short time. This fuse is very important, because it protects the batteries from overheating if you accidentally make a short circuit.

This circuit has a lot of stuff happening at once - maybe too much. If the circuit works for a while and then suddenly shuts down, then the fuse in the battery holder may have activated. Turn off the circuit, wait a little while for the fuse to reset, and then turn the circuit back on.



This complex circuit is pictured on the front of the Boffin Motion box, use that picture to help in building it.

Build the circuit as shown. Place the spout and ball on the air fountain (AF). Place the medium-small green gear on the geared motor (GM). Mount the medium-large gear on the "+" shaped bar with a rubber ring to keep it in position, place the bar in the pivot stand, and adjust the position of the green gear on it to interlock with the gear on the geared motor. Place a colored disc or some of the figures on the merry-go-round base and mount the base on the "+" shaped bar.

Assemble the airplane using the instructions on page 5, install the light motor (M7) into the front of it, build the circuit shown here, and connect the red & black jumper wires to the light motor (red to "+"). Spread out the jumper wires and be sure they will not interfere with the fan on the light motor, the gears, or the merry-go-round.

Turn on the slide switch (S1) and watch the show! The air fountain will propel the ball into the air but it may be unstable and fall off quickly. If the color LED (D8) is not flashing then tilt the circuit in different directions until it lights; set the lever on the adjustable resistor (RV2) to adjust its brightness.

NOTE: this circuit may work for a while and then suddenly shut down. If so, turn off the slide switch, wait a little while, and then turn it back on. Snappy knows what is happening. Alternately, you can remove the air fountain from the circuit, then everything else will work continuously.



Project 67

Not Too Much at Once

Mount the medium-small green gear on the geared motor, the medium-large gear and the on the "+" shaped bar, place the bar in the pivot stand and align the gears, place a colored disc or figures on the merry-go-round base and mount it on the "+" bar. If gear slides down shaft during use then add a rubber ring to keep it in place.

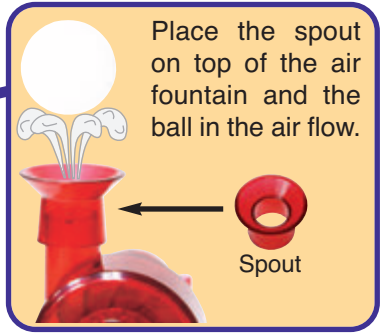
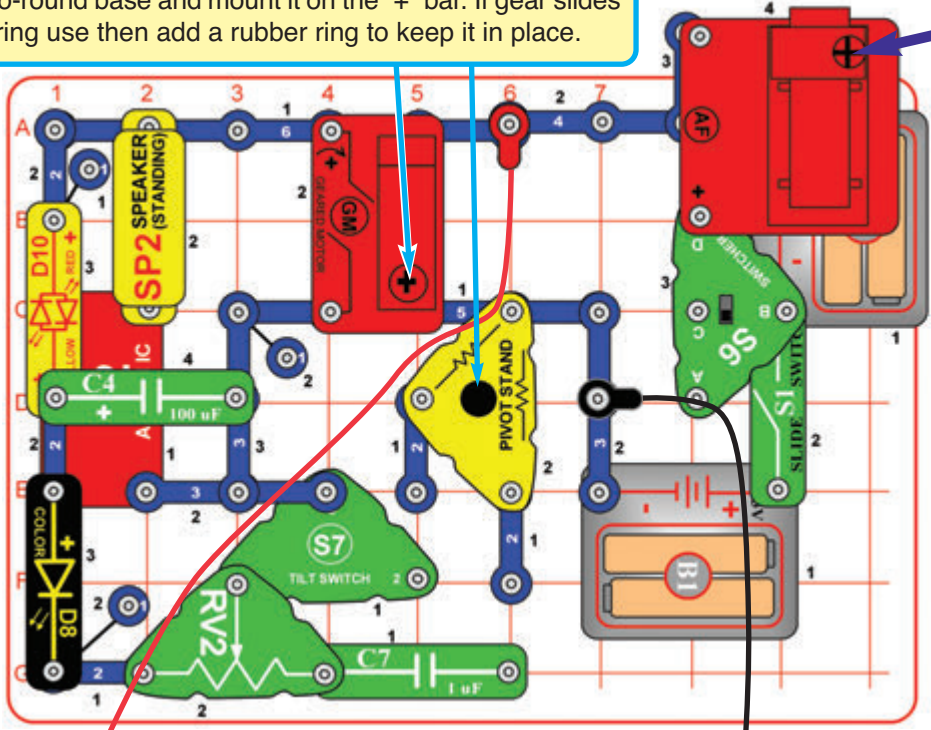

Use the preceding circuit, but remove the air fountain (AF) and reinstall it with the switcher (S6) and a 2-snap wire, as shown in the upper-right of the drawing. Note that S6 and the 2-snap overhang without support, but they should still be stable.

Turn on the slide switch (S1) to turn on the main circuit, and set the switcher to the top position to turn on the air fountain. The ball will wiggle and dance around on top of the spout, but will not rise into the air. The rest of the circuit works the same as in the preceding project.

WARNING: Moving parts. Do not touch the fan during operation.

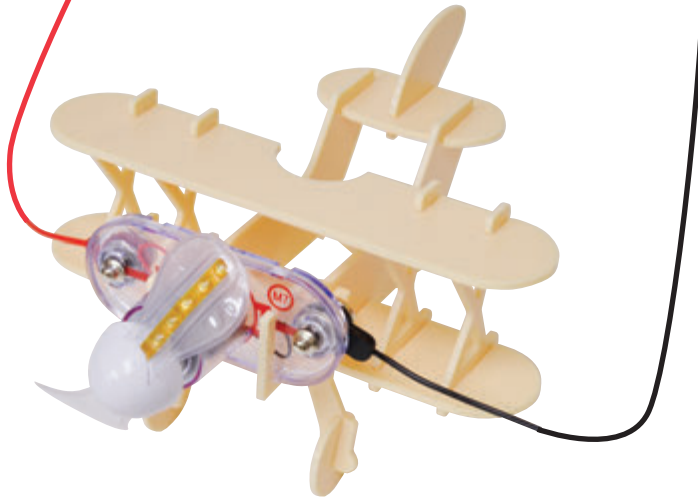

This circuit runs the air fountain (AF) at 3V instead of 6V. Now the air fountain doesn't operate at full power, but it uses less current from the batteries. The lower current here will rarely (or never) activate the fuse like it could in the preceding project, and if the fuse does activate it would only be after a much longer operating time.





Project 68

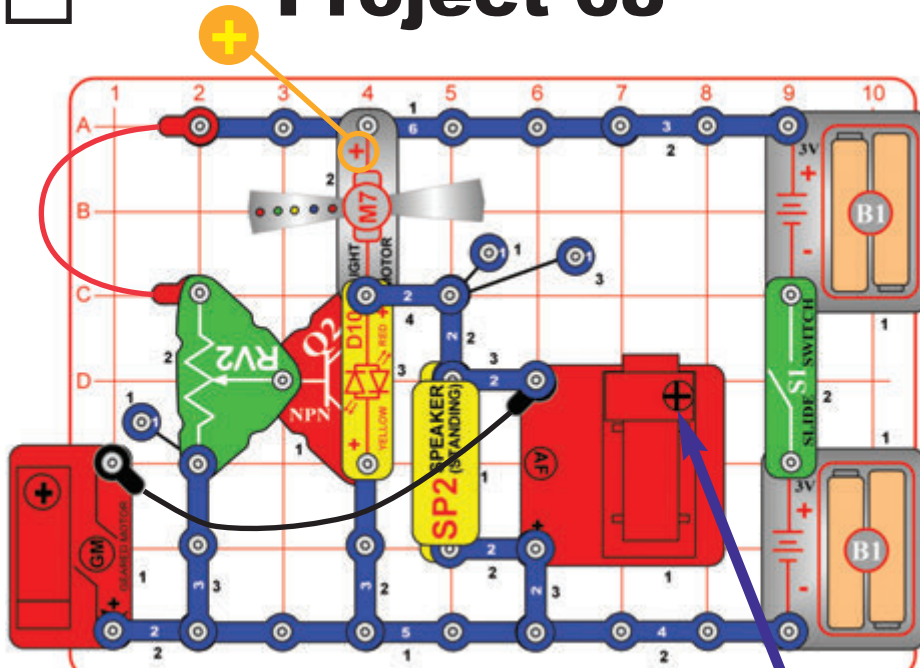

Adjustable Motor & More

Build the circuit as shown, being sure that the red & black jumper wires will not touch the fan on the light motor (M7). Place the spout and ball on the air fountain (AF). If desired, place the merry-go-round base on the geared motor (GM), but this will make it more difficult to adjust RV2.

Turn on the slide switch (S1) and watch the show! Use the lever on the adjustable resistor (RV2) to adjust the brightness of the LEDs in the light motor (M7) and red/yellow LED (D10), and also to just the power to the geared motor and air fountain. For best effects, dim the room lights. The ball may spin on the air fountain but may not rise into the air.

Be sure to try this at very low light levels (where the motor is barely spinning), as there are some cool effects. If the fan on the light motor doesn't spin, try giving it a push to get started.

WARNING: Moving parts. Do not touch the fan during operation.



Project 69

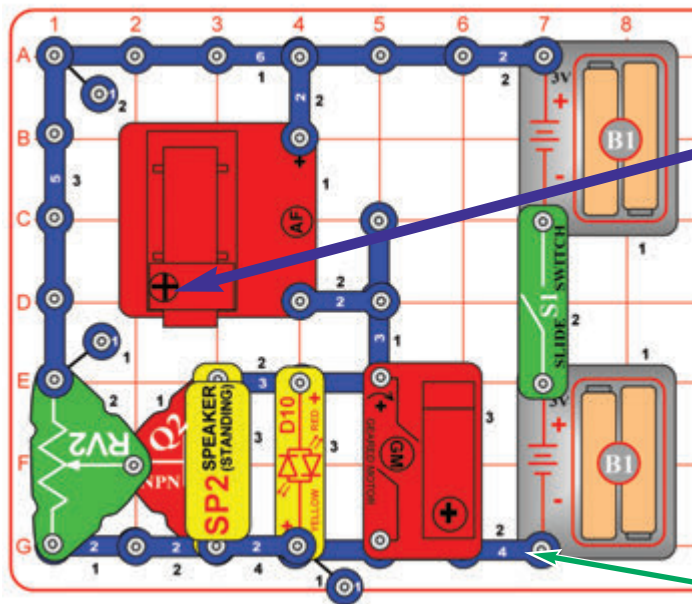

Adjustable Dancing Ball

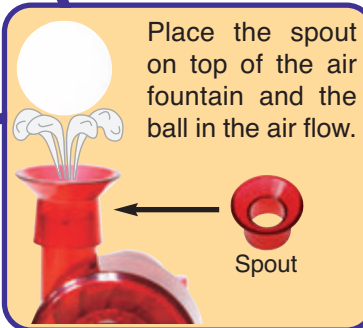

Place the spout on top of the air fountain and the ball in the air flow.

Build the circuit as shown. If desired, place the merry-go-round base on the geared motor (GM). Place the spout and ball on top of the air fountain (AF), and turn on the slide switch (S1). Use the lever on the adjustable resistor (RV2) to control the air flow, so the ball floats in the air. RV2 can be used to adjust how high the ball is floating, but at stronger air flows the ball becomes unstable and may fall out.

New alkaline batteries are recommended for this project.

You may also remove the ball and instead attach a latex glove or something else that can be inflated, as described in project 7 (Inflator).

Note: this is a 4-snap wire on level 2.

Project 70

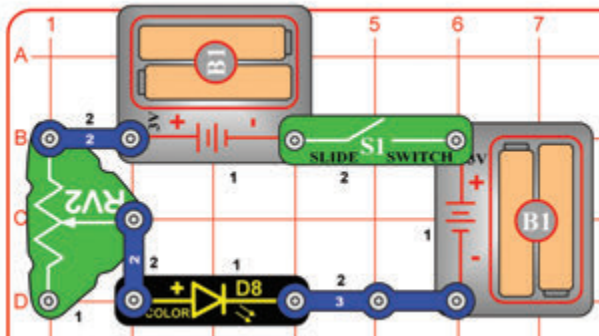

Build the circuit and turn on the slide switch (S1). Move the lever on the adjustable resistor (RV2) to vary the brightness of the light from the color LED (D8).

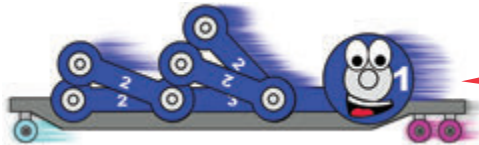

Color Brightness Adjuster

Resistors are used to control or limit the flow of electricity in a circuit. Higher resistor values reduce the flow of electricity in a circuit.

In this circuit, the adjustable resistor is used to adjust the LED brightness, to limit the current so the batteries last longer, and to protect the LED from being damaged by the batteries.

What is Resistance? Take your hands and rub them together very fast. Your hands should feel warm. The friction between your hands converts your effort into heat. Resistance is the electrical friction between an electric current and the material it is flowing through.

The adjustable resistor can be set for as low as 200Ω , or as high as $10,000\Omega$ ($10k\Omega$).

Project 71 Red or Yellow Brightness Adjuster

Use the preceding circuit but replace the color LED (D8) with the red/yellow bicolor LED (D10, oriented in either direction).

Project 72 Red & Yellow Brightness Adjuster

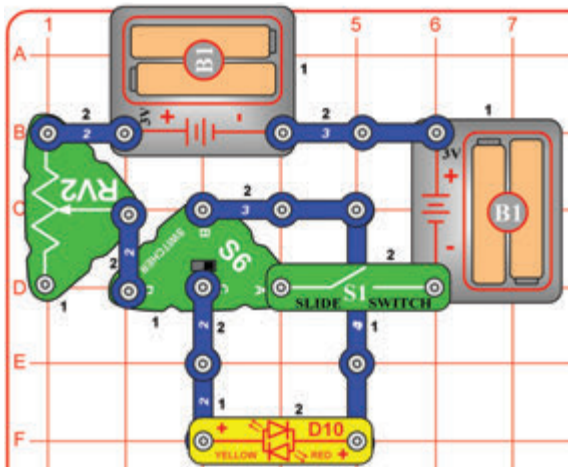

Modify the preceding circuit to match this one. With the slide switch (S1) on, use the switcher (S6) to set the color of the red/yellow bicolor LED (D10) and use the adjustable resistor (RV2) to set the brightness.

Project 73 Double Brightness Adjuster

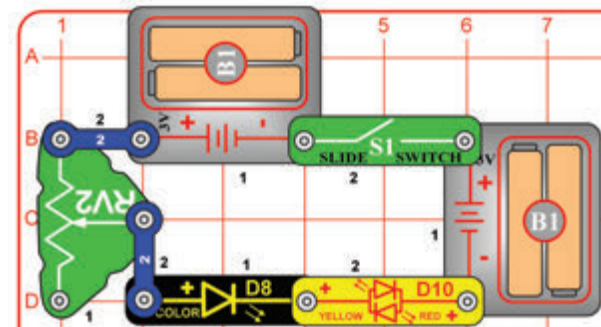

Turn on the slide switch (S1) and adjust the brightness of both LEDs (D8 & D10) using the lever on the adjustable resistor (RV2). You can flip D10 around to change its color from yellow to red.



Project 74

Two-Way Double Brightness Adjuster

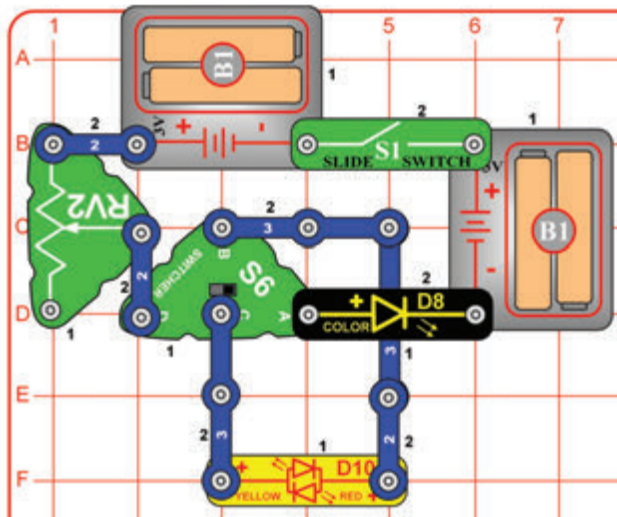

The color LED (D8) contains separate red, green, and blue lights, with a micro-circuit controlling them. The controlling circuit briefly turns the LED off between colors, which also shuts off the red/yellow LED because both are connected in series.



Build the circuit and turn on the slide switch (S1). Use the switcher (S6) to set the color of the red/yellow bicolor LED (D10) and use the adjustable resistor (RV2) to set the brightness of the LEDs.



Project 75

Parallel Double Brightness Adjuster

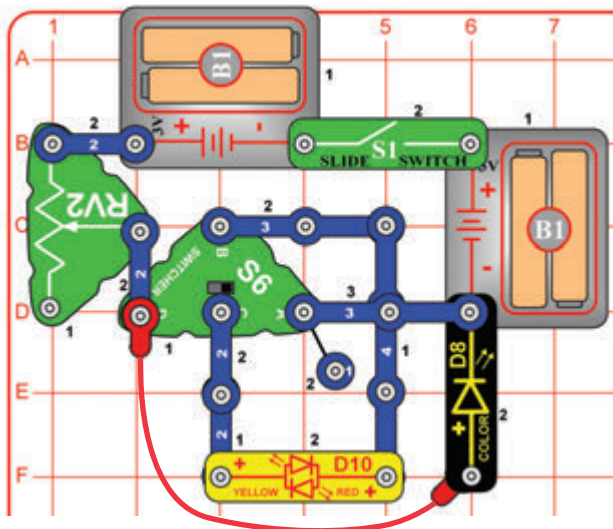

Build the circuit and turn on the slide switch (S1). Use the switcher (S6) to set the color of the red/yellow bicolor LED (D10) and use the adjustable resistor (RV2) to set the brightness of the LEDs.
Try removing the red/yellow bicolor LED from the circuit and see how it affects the color LED (D8).

This circuit has both LEDs (D8 & D10) connected in parallel with a single resistor (RV2) limiting the current through both. The LEDs have only limited brightness because the current through RV2 divides between them.
Notice how the red color in D8 is brighter than the green & blue colors it produces. This is because red is easier for the LED to produce than green & blue.

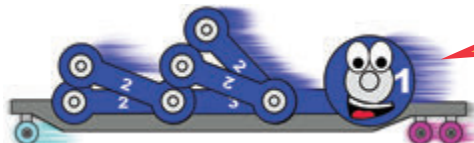

Project 76 Dim Double Brightness Adjuster

Use the preceding circuit but replace one of the battery holders (B1) with a 3-snap wire. The LEDs (D8 & D10) are dimmer now, especially on some settings for RV2.

In this circuit the current-limiting effects of RV2 are even more dominant than in the preceding circuit, due to the lower voltage. Voltage is like electrical pressure pushing current through a circuit, and this circuit has one battery holder (3V) instead of two (6V total).





Project 77

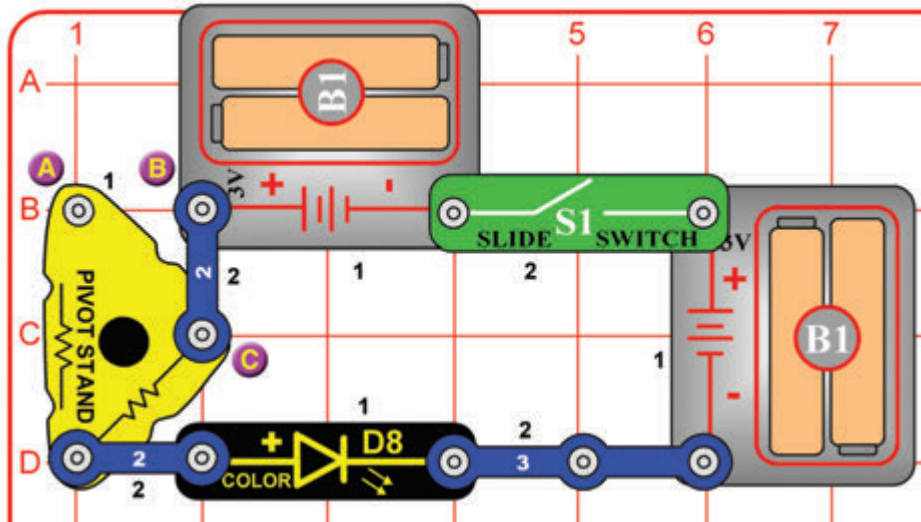

Secret Resistors

Build the circuit and turn on the slide switch (S1). The color LED (D8) is on but is not very bright.

Remove the 2-snap wire between the points marked B & C, and place it across points A & B. Now the color LED is brighter.

Hidden in the pivot stand are resistors, which control or limit the flow of electrical current. The resistance between the color LED and point C is $10,000\Omega$ (10k Ω), which is the same as the highest setting in the adjustable resistor (RV2). The resistance between the color LED and point A is 47Ω , which is lower than the lowest setting in the adjustable resistor.



Project 78 Adjustable Alarm Sounds & Light

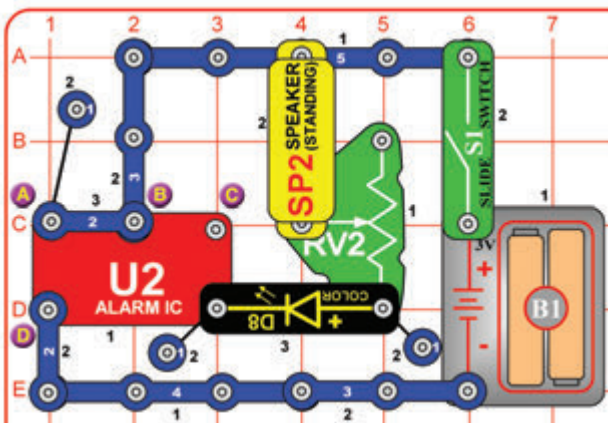

Build the circuit and turn on the slide switch (S1). Use the lever on the adjustable resistor (RV2) to change the sound volume and light brightness.

Variants: You can change the sound by removing the 1-snap and 2-snap wires that are at point A, or by moving them to be across points B & C, or across points A & D.



Project 79 Stable Adjustable Alarm Sounds & Light

Use the preceding circuit but replace the color LED (D8) with the red/yellow bicolor LED (D10, oriented in either direction). The circuit works the same way, except the light color is not changing. Try the same variants as for the preceding circuit.



Project 80 Adjustable Volume Alarms

Use the project 78 circuit but replace the color LED (D8) with a 3-snap wire. The circuit works the same way, except the sound is louder and there is no light. Try the same variants as for the project 78 circuit.



Project 81

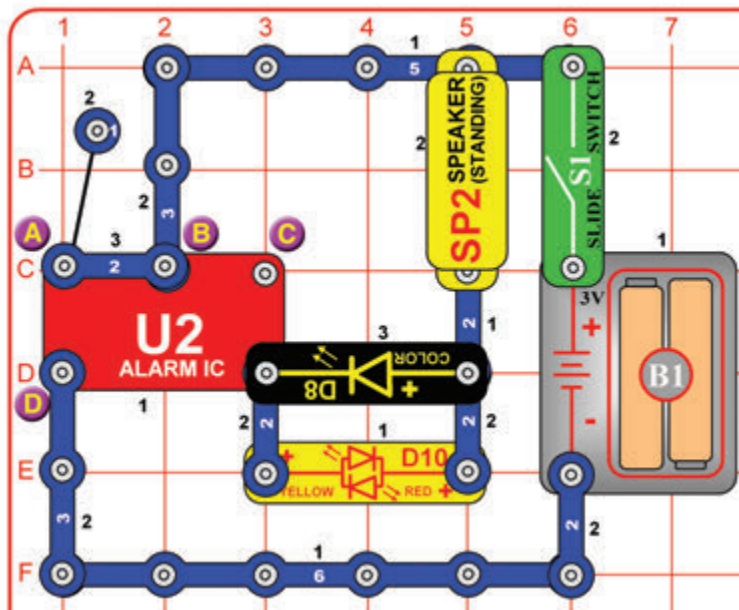

Double Red Siren

Build the circuit and turn on the slide switch (S1). A siren sounds, and two red lights are on.

Variants: You can change the sound by removing the 1-snap and 2-snap wires that are at point A, or by moving them to be across points B & C, or across points A & D. You can also reverse the orientation of the red/yellow bicolor LED (D10); then it produces yellow light instead of red light.

The color LED (D8) is mostly red color because in this arrangement there is barely enough voltage across it to turn it on, and red light is easier for it to produce than green or blue. There will be more green and blue if your batteries are strong, and less or none if they are weak.



Project 82

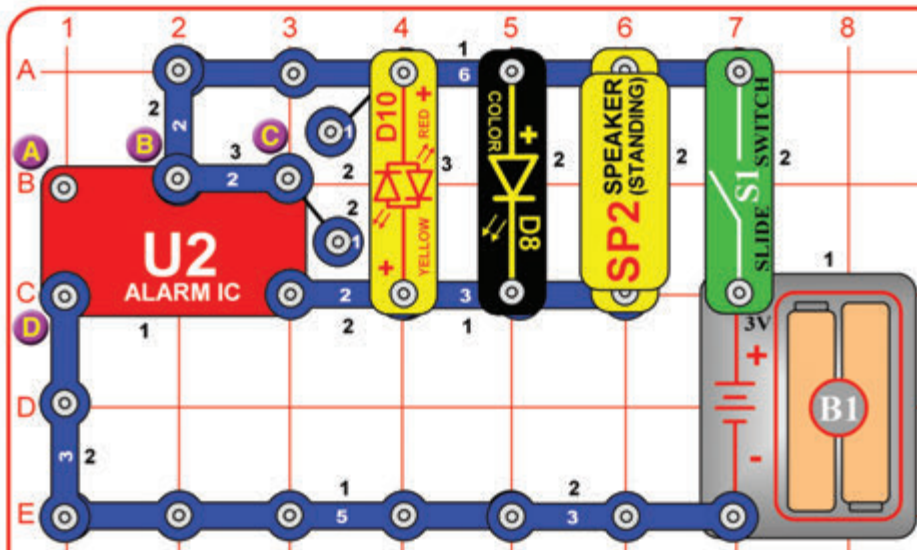

Double Lights Siren

Build the circuit and turn on the slide switch (S1). A siren sounds, and two red lights are on.

Variants: You can change the sound by removing the 1-snap and 2-snap wires that are at point C, or by moving them to be across points A & B, or across points A & D. You can also reverse the orientation of the red/yellow bicolor LED (D10); then it produces yellow light instead of red light.

The color LED (D8) doesn't change colors because the alarm IC (U2) is constantly resetting it.



Project 83

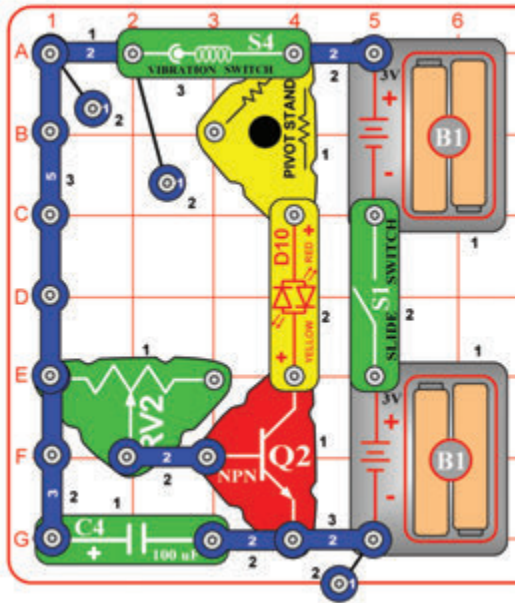

Super Vibration Light

Build the circuit as shown. Tap on the vibration switch (S4) or bang on the table to make the red/yellow LED (D10) light. The adjustable resistor (RV2) controls how long the LED stays on for.

If you reverse the orientation of the red/yellow bicolor LED (D10), then it will produce yellow light instead of red light. You can also replace the red/yellow LED with the color LED (D8, "+" towards the pivot stand).

This circuit is similar to project 11 (Vibration Light), but uses the 100µF capacitor (C4) and NPN transistor (Q2) to filter and amplify the effects of the vibration switch (S4), to keep the red/yellow LED (D10) on longer. Try removing C4 and see how the LED brightness is affected.



Project 84

Fast Vibration Light

Use the preceding circuit but replace the 100µF capacitor (C4) with the smaller 1µF capacitor (C7). The LED still flashes brightly, but now turns off quickly. Try removing C7 and see how the LED brightness is affected.

Project 85 Vibration Alarms & Lights

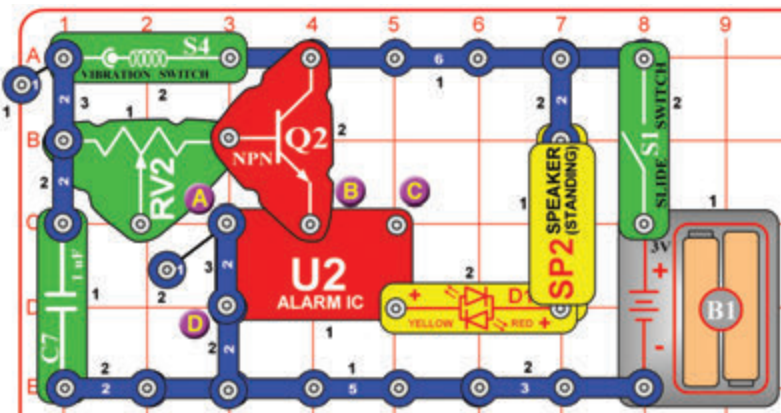

Build the circuit as shown. Tap on the vibration switch (S4) or bang on the table to activate an alarm and make the red/yellow LED (D10) light.

Variants:

- Change the sound by removing the 1-snap and 2-snap wires that are at point A, or by moving them to be across points B & C, or across points A & B.
- Replace the red/yellow LED with a 3-snap wire. The sound is louder now.
- Reverse the orientation of the red/yellow bicolor LED (D10); then it produces yellow light instead of red light.
- Replace the red/yellow LED with the color LED (D8, "+" on right).
- Replace the speaker (SP2) with a 3-snap wire or the color LED (D8, "+" on top).
- Replace the 1µF capacitor (C7) with the 100µF capacitor (C4). Now the alarm stays on for a long time.

The adjustable resistor (RV2) is used here as a fixed resistor (10kΩ value), so moving its lever won't do anything.

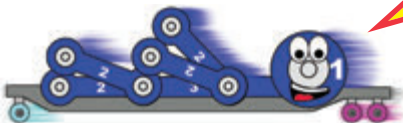

Project 86

Shaky Alarms & Lights

Use the preceding circuit (including any of its variants) but connect the vibration switch (S4) using the red & black jumper wires, as shown. Nothing happens if you hold S4 steady in your hand. Shaking S4 activates alarms & lights.

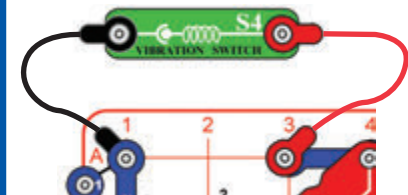



Project 87

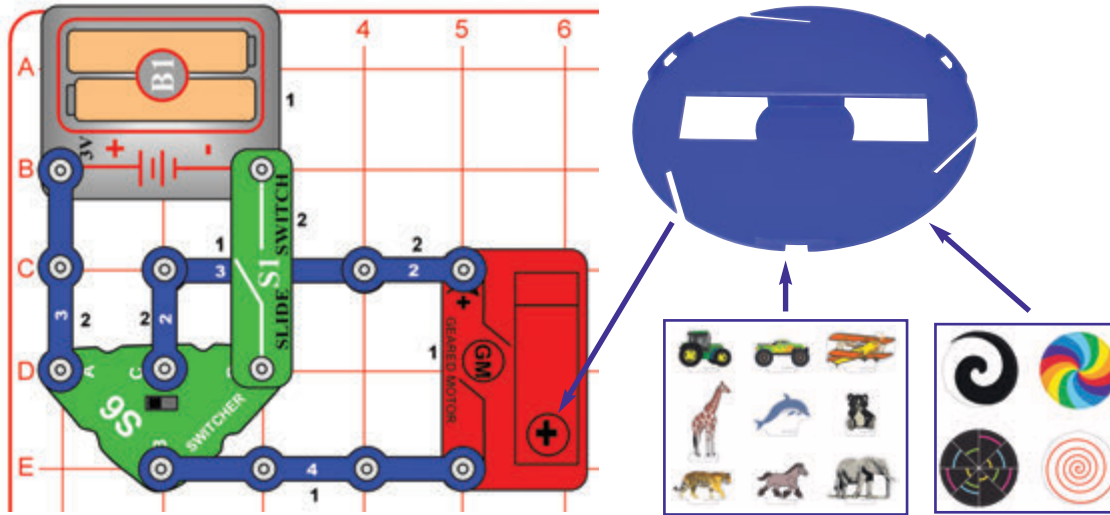

Reversible Merry-Go-Round

Either insert some of the cardboard figures into the 3 slots on the edge of the merry-go-round base, or install one of the colored discs into the base. Build this circuit and mount the merry-go-round base onto the shaft on the geared motor (GM).

Turn on the slide switch (S1), and then make the figures or disc change direction using the switcher (S6).



Project 88

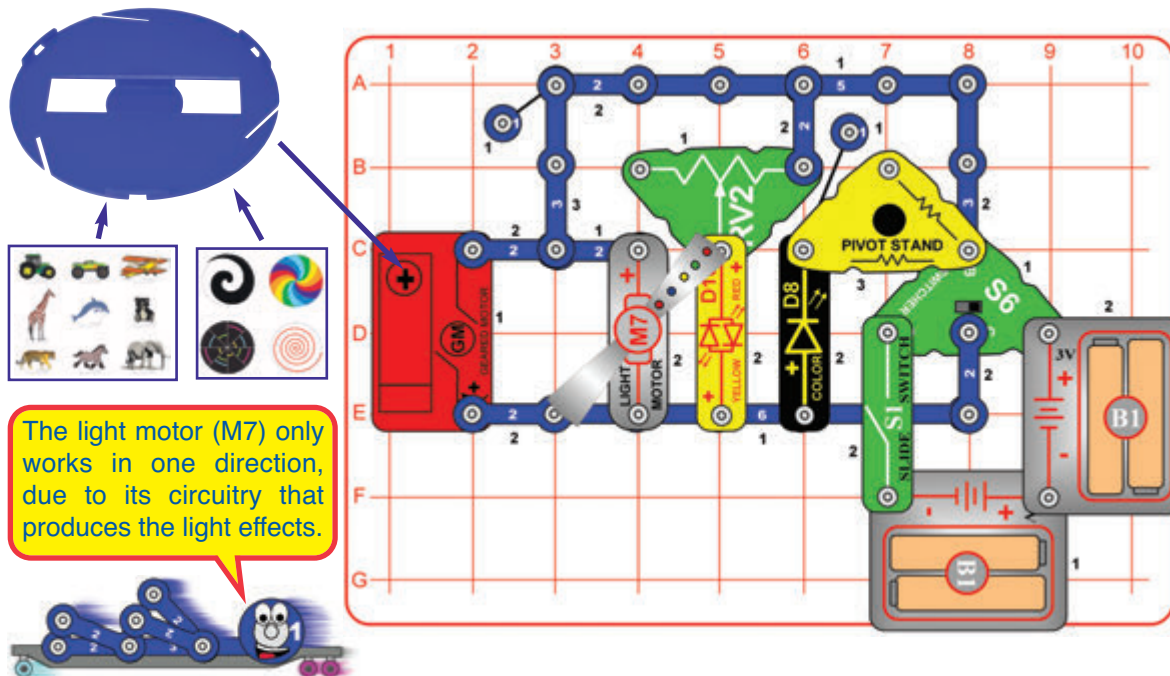

The light motor (M7) only works in one direction, due to its circuitry that produces the light effects.



Two-Way Circuit

Either insert some of the cardboard figures into the 3 slots on the edge of the merry-go-round base, or install one of the colored discs into the base. Build this circuit and mount the merry-go-round base onto the shaft on the geared motor (GM).

Set the lever on the adjustable resistor (RV2) to the right. Turn on the slide switch (S1), and use the switcher (S6) to make things spin in different directions and make different lights come on.



Project 89 Low Power Two-Way Circuit

Use the preceding circuit but replace one of the battery holders (B1) with a 3-snap wire. Things move slower now and lights are dimmer.



Project 90

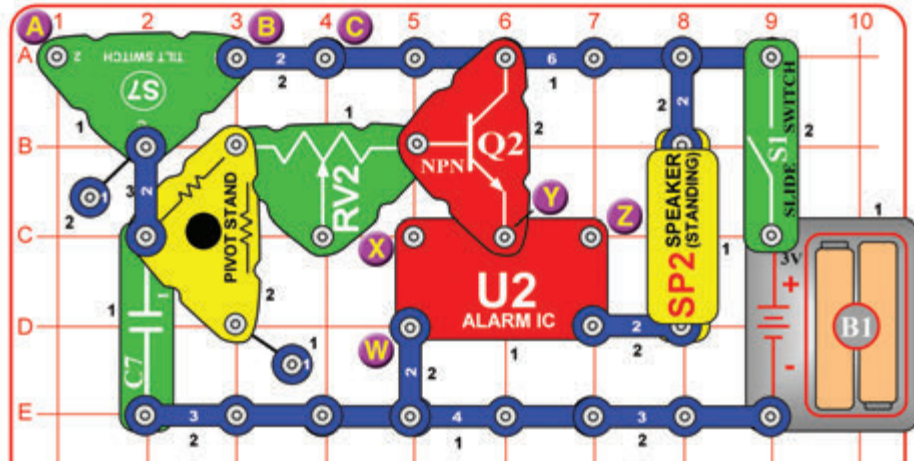

When tilt is detected, the $1\mu\text{F}$ capacitor (C7) is charged through the tilt switch (S1). When tilt is removed, the capacitor discharges through the resistors in the pivot stand and RV2, and through the NPN transistor (Q2). The alarm stays on as the capacitor discharges.

You can make the alarm shut off faster after tilt is removed by disconnecting C7, or by connecting the black jumper wire across the pivot stand or adjustable resistor.



Slow Off Tilt Alarm

Build the circuit and turn on the slide switch (S1). An alarm sounds if the circuit is moved, or tilted in some directions. The alarm stays on for about 2 seconds after the tilt is removed. Moving the lever on the adjustable resistor (RV2) won't do anything.

If the circuit does not shut off when left alone on a flat surface, then tilt it slightly so it turns off.

Remove the 2-snap wire between points B & C, and connect the red jumper wire between points A & C. Now the alarm is activated by different tilt angles.

If you place keep in the 2-snap wire between points B & C and connect the red jumper wire between points A & B, then the circuit will be so sensitive to tilt that the alarm may be difficult to shut off.

Also, you can change the alarm sound by using a 1-snap wire and a 2-snap wire to make a connection between points W & X, or X & Y, or Y & Z on the alarm IC (U2).

Finally, replace the $1\mu\text{F}$ capacitor (C7) with the $100\mu\text{F}$ capacitor (C4). Now the alarm stays on much longer, and may appear to never shut off.



Project 91

Slow Off Tilt Light

Use the preceding circuit but replace the speaker (SP2) with the color LED (D8, "+" on top) or the red/yellow bicolor LED (D10, in either orientation). The circuit works the same but has light instead of sound. Try it with both LEDs (D8 & D10), separately.

The variants in project 90 regarding different connections to points A-B-C and W-X-Y-Z, and the $100\mu\text{F}$ capacitor (C4) can also be used here. Adding the connection between W & X may be the most interesting variant.

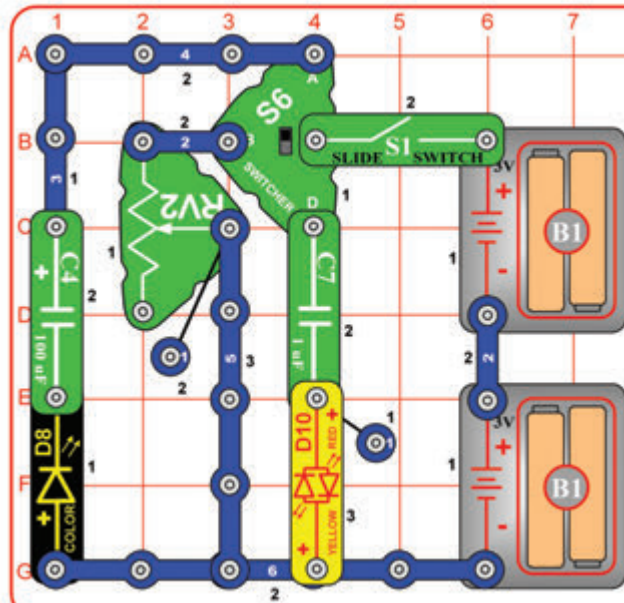

Project 92

Switcher Fun

Turn on the slide switch (S1), then alternate between setting the switcher (S6) to the top and bottom positions. Try this at different settings on the adjustable resistor (RV2).

Next, swap the locations of the color LED (D8) and red/yellow bicolor LED (D10).

Next, reverse the orientations of the LEDs (D8 & D10).

The LEDs (D8 & D10) will light, sometimes briefly and dimly, as the capacitors are charged and discharged.

Project 93

Adjustable Slow Off Tilt Light

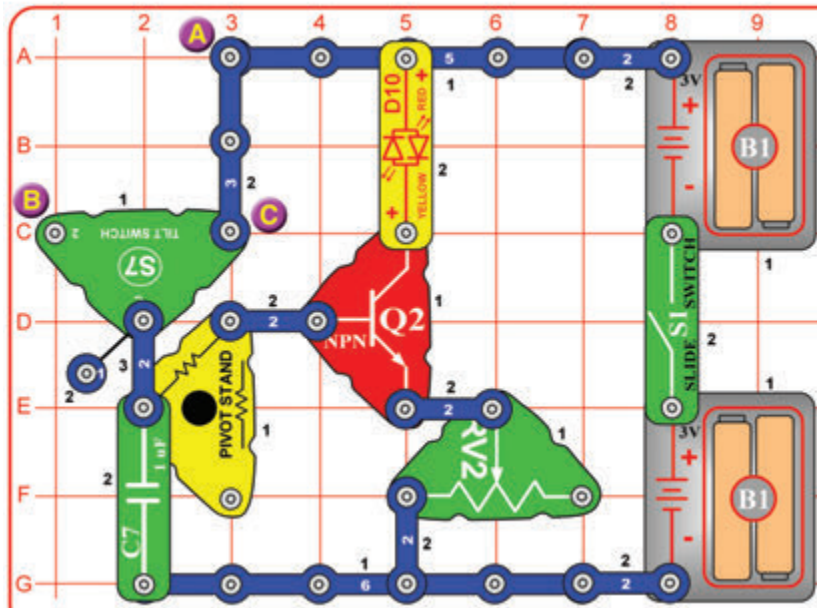

When tilt is detected, the 1µF capacitor (C7) is charged through the tilt switch (S7). When tilt is removed, the capacitor discharges through the resistors in the pivot stand and RV2, and through the NPN transistor (Q2). The light stays on as the capacitor discharges. RV2 also limits the current through the LED (D10), and so affects the LED brightness.

You can make the light shut off faster after tilt is removed by disconnecting C7, or by connecting the black jumper wire across the pivot stand.



Build the circuit and turn on the slide switch (S1). A light comes on if the circuit is moved, or tilted in some directions. The light stays on for a while after the tilt is removed. The lever on the adjustable resistor (RV2) controls the maximum light brightness and how long the light stays on after tilt is removed; the brighter the light, the faster it shuts off.

If the circuit does not shut off when left alone on a flat surface, then tilt it slightly so it turns off.

Remove the 3-snap wire between points A & C, and connect the red jumper wire between points A & B. Now the alarm is activated by different tilt angles.

If you keep in the 3-snap wire between points B & C and connect the red jumper wire between points A & B, then the circuit will be so sensitive to tilt that the alarm may be difficult to shut off.

Project 94

Color Slow Off Tilt Light

Use the preceding circuit but replace the red/yellow bicolor LED (D10) with the color LED (D8, "+" on top). You can also keep the red/yellow bicolor LED in the circuit but reverse its orientation, so it makes yellow light.

Project 95

Very Slow Off Tilt Light

Use the preceding circuit with either the D8 or D10 LEDs, but replace the 1µF capacitor (C7) with the larger 100µF capacitor (C4). The circuit works the same but the larger capacitor will keep the LED on longer. Set RV2 to the left side or the LED may seem to stay on too long.

Project 96 Bright Slow Off Tilt Light

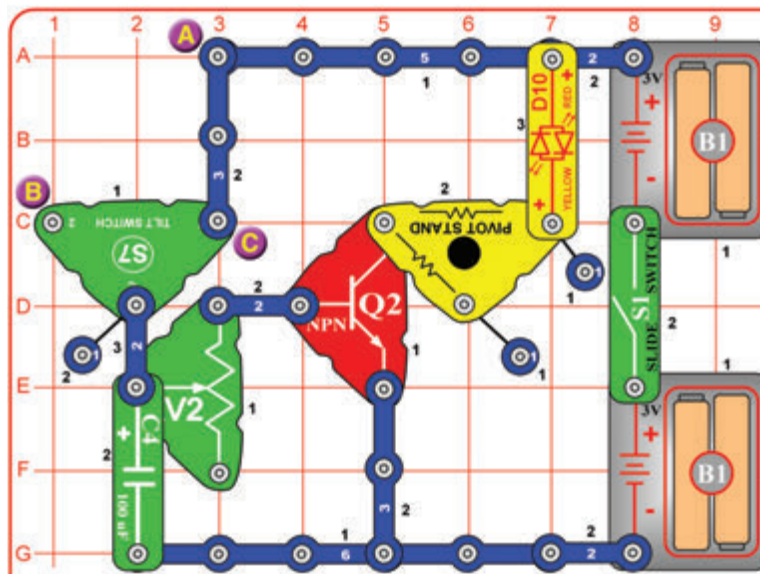

Modify the preceding circuit to be this one. Turn on the slide switch (S1). A light comes on if the circuit is moved, or tilted in some directions. The light stays on for a while after the tilt is removed. The lever on the adjustable resistor (RV2) controls how long the light stays on after tilt is removed.

If the circuit does not shut off when left alone on a flat surface, then tilt it slightly so it turns off.

Remove the 3-snap wire between points A & C, and connect the red jumper wire between points A & B. Now the alarm is activated by different tilt angles.



Project 97

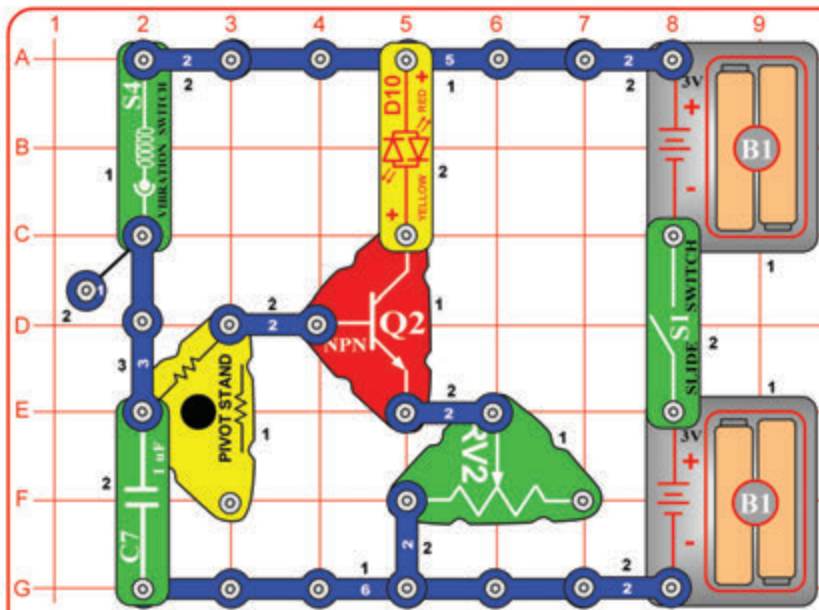

Adjustable Slow Off Vibration Light

Build the circuit and turn on the slide switch (S1). Bang on the table or tap on the vibration switch (S4) and a light comes on. The light stays on for a while after the vibrations end. The lever on the adjustable resistor (RV2) controls the maximum light brightness and how long the light stays on after vibrations end; the brighter the light, the faster it shuts off.

When vibration is detected, the 1µF capacitor (C7) is charged through the vibration switch (S4). When vibrations end, the capacitor discharges through the resistors in the pivot stand and RV2, and through the NPN transistor (Q2). The light stays on as the capacitor discharges. RV2 also limits the current through the LED (D10), and so affects the LED brightness. You can make the light shut off faster after vibrations end by disconnecting C7, or by connecting the black jumper wire across the pivot stand.



Project 98

Color Slow Off Vibration Light

Use the preceding circuit but replace the red/yellow bicolor LED (D10) with the color LED (D8, "+" on top). You can also keep the red/yellow bicolor LED in the circuit but reverse its orientation, so it makes yellow light.



Project 99

Very Slow Off Vibration Light

Use the preceding circuit with either the D8 or D10 LEDs, but replace the 1µF capacitor (C7) with the larger 100µF capacitor (C4). The circuit works the same but the larger capacitor will keep the LED on longer. Set RV2 to the left side or the LED may seem to stay on too long.



Project 100

Bright Slow Off Vibration Light

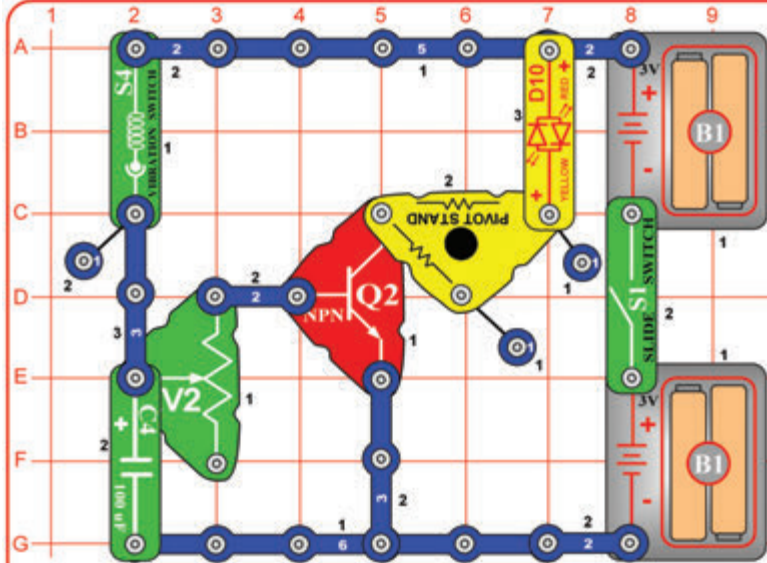

Modify the preceding circuit to be this one. Turn on the slide switch (S1). Bang on the table or tap on the vibration switch (S4) and a light comes on. The light stays on for a while after the vibrations end. The lever on the adjustable resistor (RV2) controls the maximum light brightness and how long the light stays on after vibrations end; the brighter the light, the faster it shuts off.

Project 101 Slow Off Tilt Lights

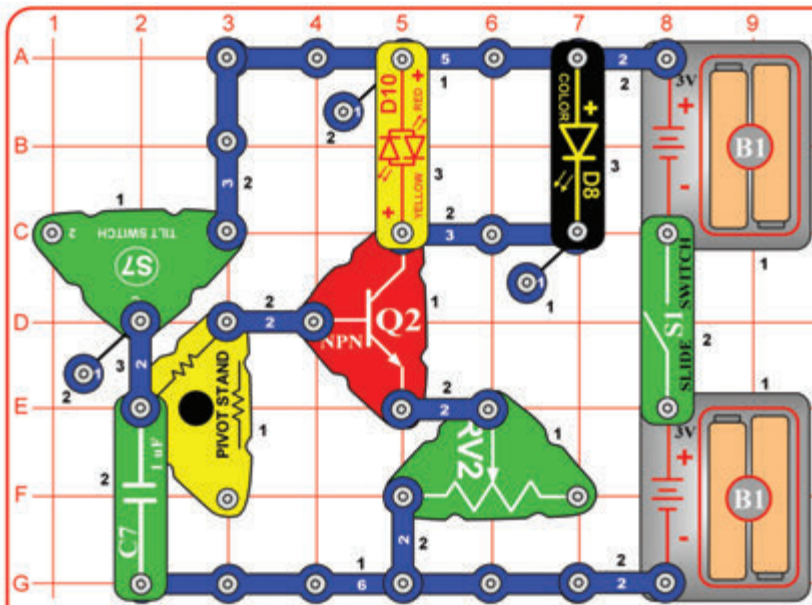

Build the circuit and turn on the slide switch (S1). Lights come on if the circuit is moved, or tilted, in some directions. The lights stay on for a while after the tilt is removed. The lever on the adjustable resistor (RV2) controls the maximum light brightness and how long the lights stay on after tilt is removed; the brighter the lights, the faster they shut off.

The LEDs (D8 & D10) will not be as bright as in the preceding circuit, because the current (which is limited by RV2) is divided between them. The color LED may only produce red light, because red light is easier to produce.



Project 102 Very Slow Off Tilt Lights

Use the preceding circuit, but replace the 1µF capacitor (C7) with the larger 100µF capacitor (C4). The circuit works the same but the larger capacitor will keep the LEDs on longer. Set RV2 to the left side or the LED may seem to stay on too long.

Project 103 Slow Off Vibration Lights

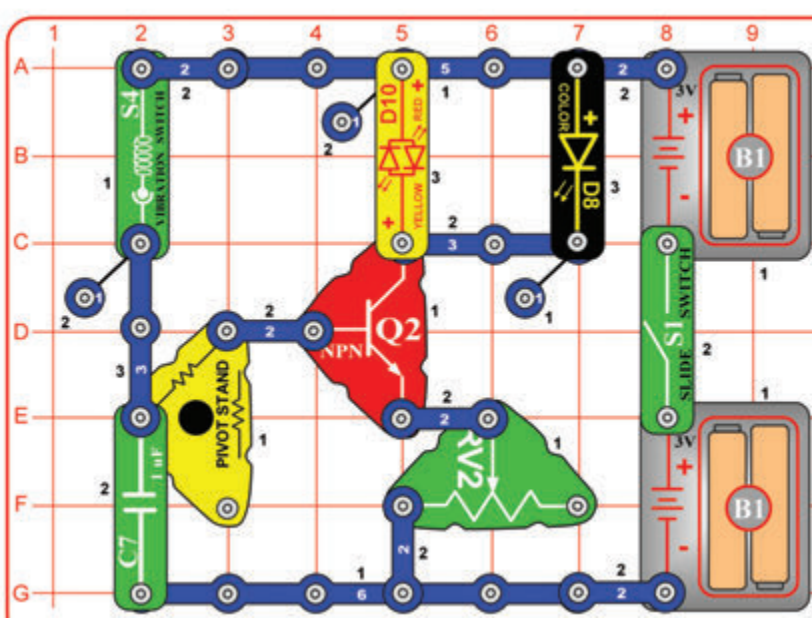

Build the circuit and turn on the slide switch (S1). Bang on the table or tap on the vibration switch (S4) and lights come on. The lights stay on for a while after the vibrations end. The lever on the adjustable resistor (RV2) controls the maximum light brightness and how long the lights stay on after vibrations end; the brighter the lights, the faster they shut off.

The LEDs (D8 & D10) will not be as bright as in the preceding circuit, because the current (which is limited by RV2) is divided between them. The color LED may only produce red light, because red light is easier to produce.



Project 104 Very Slow Off Vibration Lights

Use the preceding circuit, but replace the 1µF capacitor (C7) with the larger 100µF capacitor (C4). The circuit works the same but the larger capacitor will keep the LEDs on longer. Set RV2 to the left side or the LED may seem to stay on too long.



Project 105

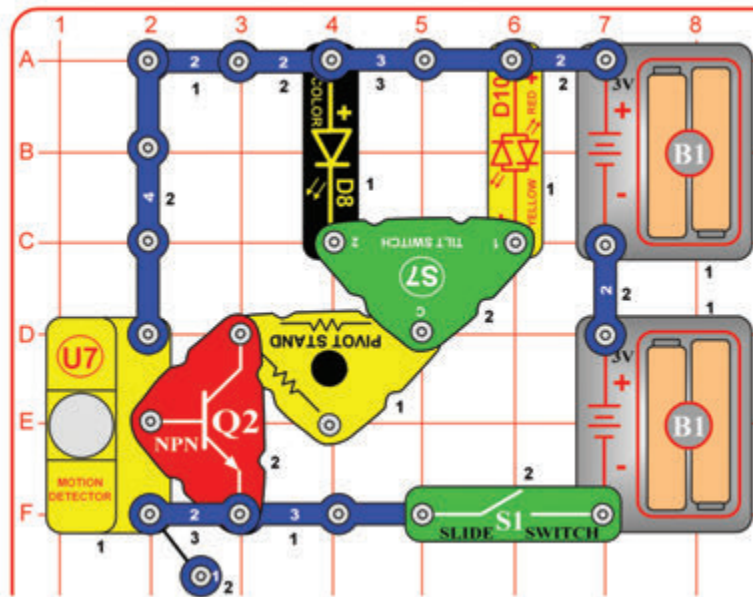

Tilted Motion Detector

Build the circuit and turn on the slide switch (S1). One of the LEDs (D8 & D10) lights if the circuit detects motion in the room WHILE it is being tilted at some angles. Experiment to see which tilt angles activate which LED.



Project 106

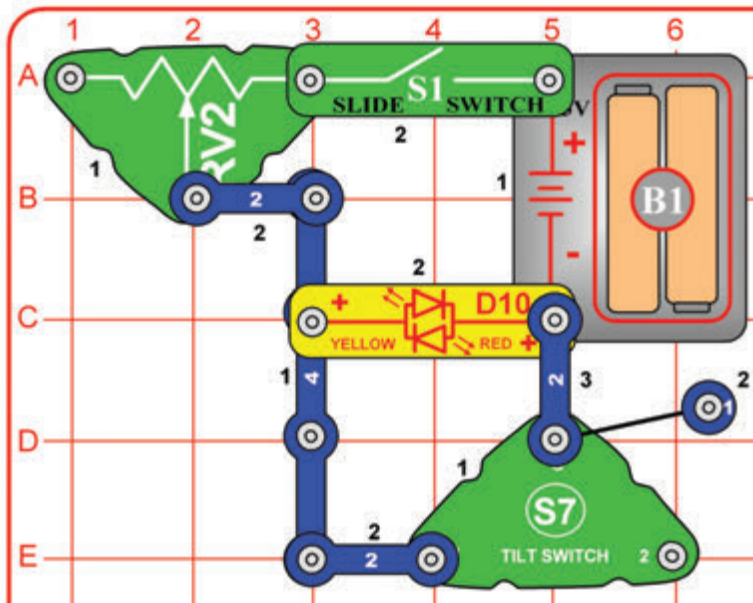

Tilt Off

Build the circuit as shown, set the lever on the adjustable resistor (RV2) to the right, and turn on the slide switch (S1). The red/yellow bicolor LED (D10) is on unless the circuit is tilted or moved.

If the LED is off when the circuit is left alone on a flat surface, then tilt it slightly so it turns on.

If desired, reverse the orientation of the red/yellow bicolor LED, or replace it with the color LED (D8, "+" on left).

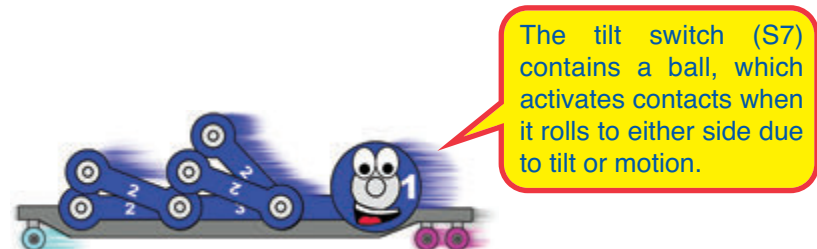

Project 107

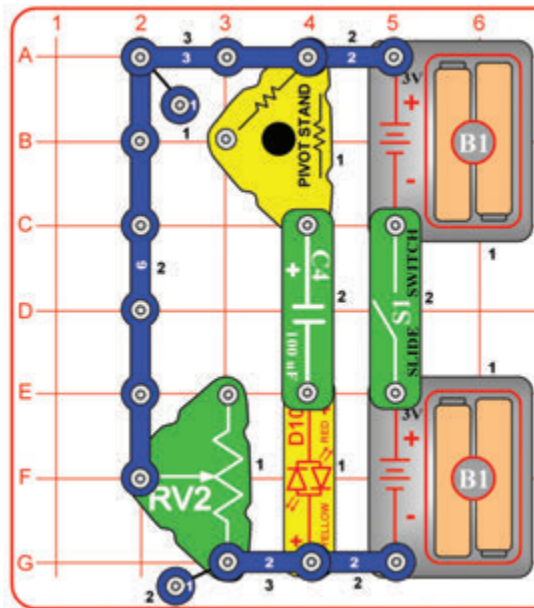

Electricity In, Electricity Out

Turn on the slide switch (S1); the red/yellow bicolor LED (D10) flashes red. Now turn off the slide switch; the LED flashes yellow. The lever on the adjustable resistor (RV2) controls the LED brightness; setting it up makes the flash dimmer but lasting longer, while setting it down makes the LED flash bright but brief.

When you turn on the slide switch, the LED (D10) flashes red as electricity from the batteries charges up the 100µF capacitor (C4). The capacitor can store electricity, but can't store very much, so charges up quickly.

When you turn off the slide switch, the LED flashes yellow as the electricity in the capacitor discharges through the adjustable resistor (RV2). The red/yellow bicolor LED shines a different color now because electricity is flowing in the opposite direction. The setting on RV2 controls how fast the capacitor can discharge.



Project 108 Little Electricity In/Out

Use the preceding circuit but replace the 100µF capacitor (C4) with the 1µF capacitor (C7). The circuit works the same, but the LED will only light very briefly, because the smaller 1µF capacitor stores much less electricity than the larger 100µF capacitor. Do this in a dimly lit room so you can see the flashes better.

Project 109

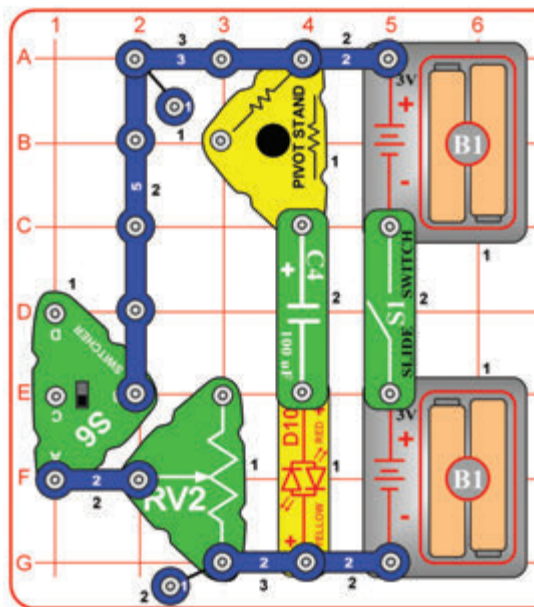

Mini Rechargeable Battery

The 100µF capacitor (C4) is like a mini rechargeable battery because it can store electricity. In this circuit, turning on S1 charges up the capacitor, which holds the electricity after S1 is turned off. Turning on S6 creates a circuit path through RV2 for the capacitor to discharge through.

Capacitors store electricity in the form of an electric field while batteries store it as chemical energy. Because of this, capacitors can't store nearly as much electricity as batteries, but can store and release it much faster.

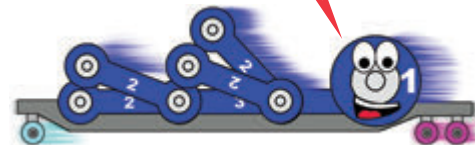

Modify the preceding 2 circuits to include the switcher (S6), as shown here. Set the switcher to the middle position. Turn on the slide switch (S1); the red/yellow bicolor LED (D10) flashes red. Now turn off the slide switch, wait a little, then set the switcher to the bottom position; the LED flashes yellow. Set the switcher back to the middle position, and you are ready to do it again.

As before, the lever on the adjustable resistor (RV2) controls the LED brightness; setting it up makes the flash dimmer but lasting longer, while setting it down makes the LED flash bright but brief.



Project 110

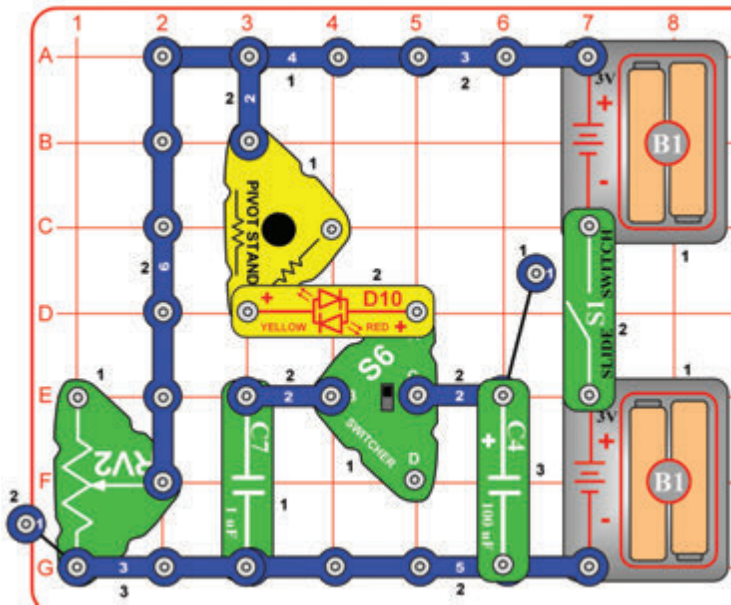

Mini Rechargeable Batteries

This circuit is similar to the preceding three circuits, but uses the switcher (S6) as a three-way switch so it is easier to compare the difference between the $1\mu\text{F}$ & $100\mu\text{F}$ capacitors (C7 & C4).

With S6 set to the middle position: neither capacitor is connected to the circuit, so nothing will happen when you turn the slide switch (S1) on or off.

With S6 set to the top position: The $1\mu\text{F}$ capacitor (C7) is connected to the red/yellow bicolor LED (D10). Turn on S1; the LED flashes yellow as C7 charges. Turn S1 off; the LED flashes red as C7 discharges. The adjustable resistor (RV2) controls the capacitor discharge rate, making the LED either flash brighter or stay on longer.

With S6 set to the bottom position: The larger $100\mu\text{F}$ capacitor (C4) is connected to the red LED. Turn on S1; the LED flashes yellow as C4 charges. Turn S1 off; the LED flashes red as C4 discharges. The LED is brighter because C4 can store a lot more electricity than C7 could. The adjustable resistor (RV2) controls the capacitor discharge rate, making the LED either flash brighter or stay on longer.



Project 111

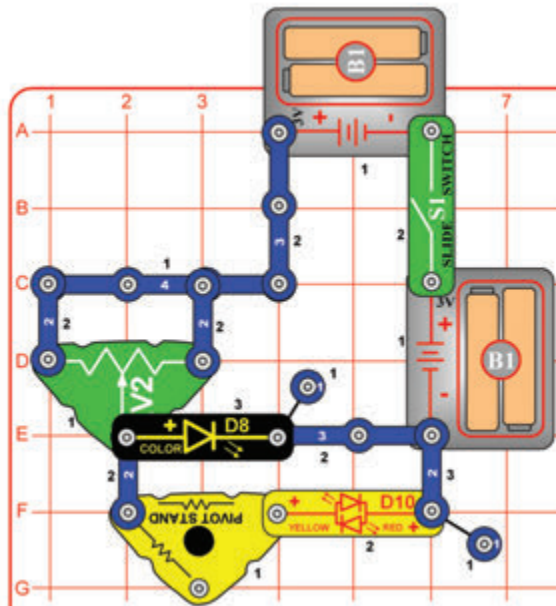

Left Right Bright Lights

Turn on the slide switch (S1) and move the lever on the adjustable resistor (RV2) around. The LEDs (D8 & D10) are bright if the lever is to the far left or far right, and dim if the lever is in the middle.

Try removing the color LED (D8). This makes it easier to see the effects on the red/yellow LED (D10), because it will not be blinking anymore. You can also reverse the orientation of the red/yellow LED.



Project 112

Charge & Discharge

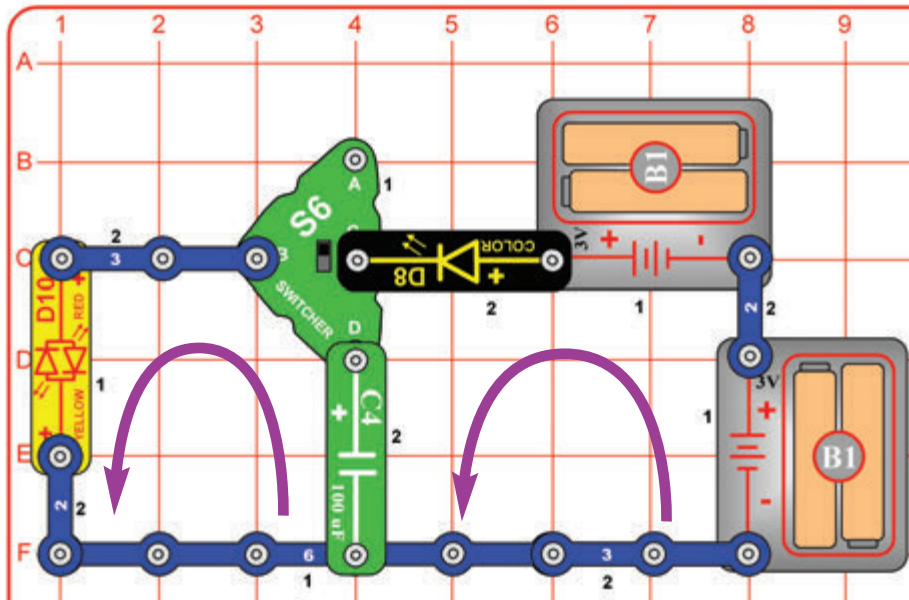

Set the switch (S6) to the top position; the color LED (D8) flashes. Now set S6 to the bottom position; the red/yellow bicolor LED (D10) flashes red. Alternate setting S6 to top and then bottom. The middle S6 position is "off".

When the switch (S6) is set to the top position, points C & D (marked directly on S6) are connected. When S6 is set to the bottom position, points B & D on it are connected. When S6 is set to the middle position, nothing is connected.

When C & D are connected (S6 to top), electricity from the batteries quickly charges up the 100µF capacitor (C4) through the color LED (D8), making the LED flash. The charged capacitor holds its charge even if S6 is turned off, or if C4 is temporarily removed from the circuit.

When B & D are connected (S6 to bottom), the electricity in the capacitor quickly discharges through the red/yellow LED (D10), making it flash.



Project 113 Super Charge & Discharge



Project 114 Mini Charge & Discharge

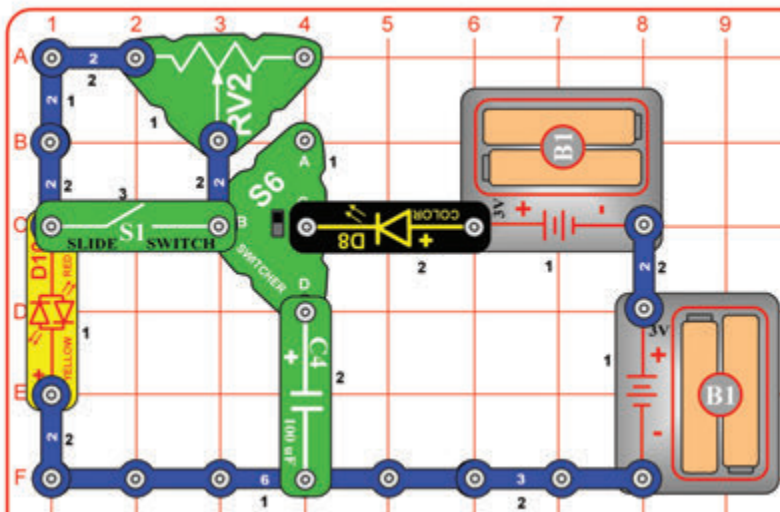

Modify the preceding circuit to match this one. Turn off the slide switch (S1); now the adjustable resistor (RV2) controls how quickly the 100µF capacitor (C4) discharges through the red/yellow LED (D10). Setting RV2 to the left makes D10 flash brightly but briefly; setting RV2 to the right makes the LED dimmer but it stays on longer.

When the slide switch (S1) is on, the adjustable resistor is bypassed, making the circuit the same as the preceding one. This makes it easy for you to compare the circuits.

The adjustable resistor limits the current flow, slowing down the discharge of electricity from the 100µF capacitor.



Use the preceding circuit but replace the 100µF capacitor (C4) with the 1µF capacitor (C7). The circuit works the same, but the LED will only light very briefly, because the smaller 1µF capacitor stores much less electricity than the larger 100µF capacitor. Do this in a dimly lit room so you can see the flashes better.



Project 115

Light Start

WARNING: Moving parts. Do not touch the fan during operation.

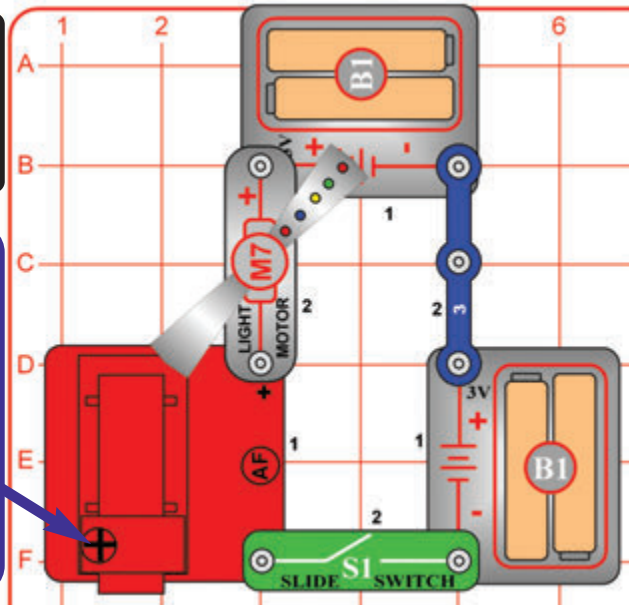
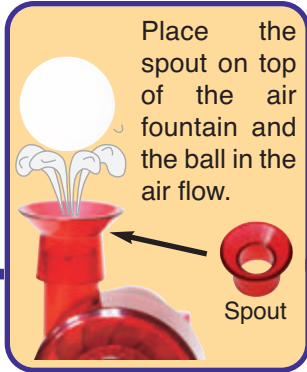

Motors need lots of electric current when they start up, then much less when their shafts are spinning at high speed (it is harder to get the shaft spinning than to keep it spinning). Compare this to riding a bicycle: you have to pedal harder to get going, then it's easy to keep going at a constant speed.

Both the light motor and air fountain are going at start, because both need lots of electric current. Once it is blowing lots of air, the air fountain needs less current, but that amount is too little for the light motor. The air fountain and light motor must have the same current through them because they are connected in series, so the air fountain limits the current, "choking" the light motor and making it shut down.

Build the circuit as shown. Place the spout on the air fountain (AF) and place the ball in it. Turn on the slide switch (S1). The light motor (M7) spins and lights brightly at start, but then gets dimmer and may even stop as the air fountain gets going. The ball will spin around in the spout and might rise into the air.

If you replace one of the battery holders (B1) with a 3-snap wire, the light motor may not even start, and the air fountain will barely move the ball. The voltage is too low and cannot push enough electric current through the circuit to get everything going.



Project 116

Double Motion

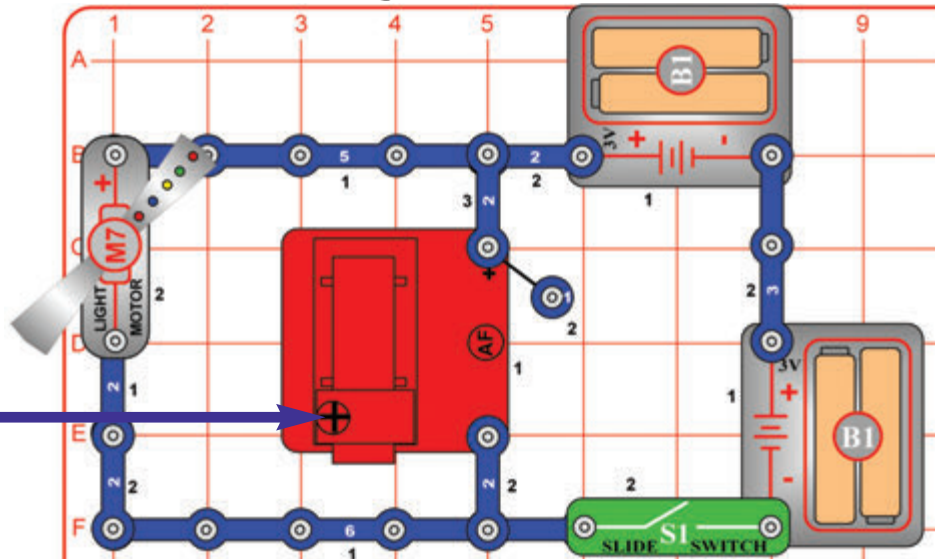

WARNING: Moving parts. Do not touch the fan during operation.

Compare this circuit to the preceding one. Here the light motor and air fountain are connected in parallel, so the electric currents flowing through them can be different, and they are basically independent of each other. Each gets what it needs from the batteries, and both work properly. Another advantage of connecting parts in parallel is that if one breaks, the others keep working.

The advantages of connecting parts in series (as done in the preceding circuit), is that the circuit wiring is less complex, and the batteries will last longer.

Build the circuit as shown, turn on the slide switch (S1). Both the light motor (M7) and air fountain (AF) are going. Place the ball directly in the blowing air above the air fountain. The blowing air should balance the ball, so it floats in the air and "dances".

Occasionally the ball may become unstable and fall out; just place it back into the air flow. If the ball falls out easily then reverse the orientation of the air fountain.

If you replace one of the battery holders (B1) with a 3-snap wire, the light motor and the air fountain will still operate, though you may need to give the light motor's fan a push to get started. Performance will be better with new batteries.





Project 117

Triple Motion

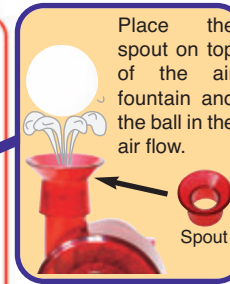
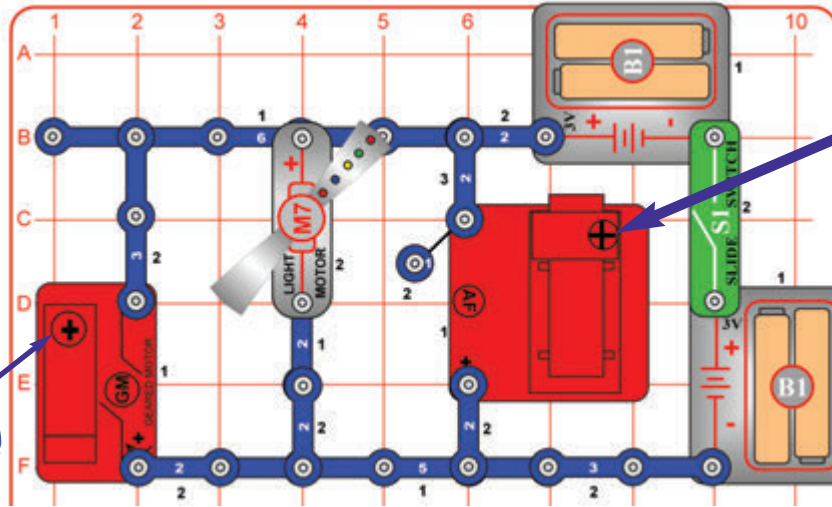
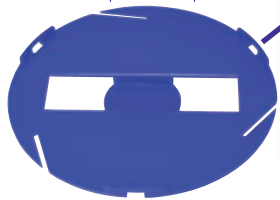

Build the circuit. Place the merry-go-round base on the geared motor (GM) shaft; if desired, insert some of the cardboard figures into the base or install one of the colored discs into it. Turn on the slide switch (S1).

The geared motor spins the merry-go-round, the light motor (M7) spins and lights, and the air fountain (AF) blows air. Place the ball directly in the blowing air above the air fountain. The blowing air should balance the ball, so it floats in the air and "dances". Occasionally the ball may become unstable and fall out; just place it back into the air flow.

NOTE: this circuit may work for a while and then suddenly shut down. If so, turn off the slide switch, wait a little while, and then turn it back on. Snappy explains why in project 66.

WARNING: Moving parts. Do not touch the fan during operation.

Project 118

Slow Triple Motion

Use the preceding circuit but replace one of the battery holders (B1) with a 3-snap wire. Now the merry-go-round (on the geared motor (GM)) spins slower, the light motor barely spins & lights (it may even need a push to get started), and the air fountain may not be able to get the ball into the air. The difference in performance will be greater if your batteries are weak.

Project 119

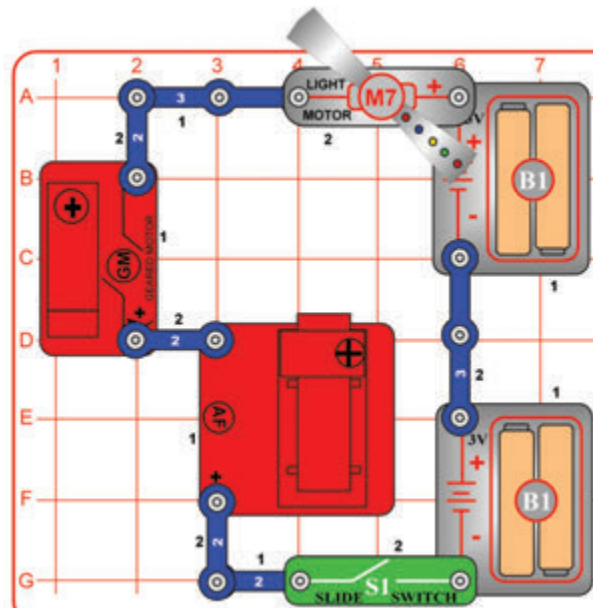

Dominator

Build the circuit. If desired, place the merry-go-round base on the geared motor (GM) shaft and insert some of the cardboard figures into the base or install one of the colored discs into it. Turn on the slide switch (S1).

The geared motor shaft may spin, the light motor (M7) may spin, and the air fountain (AF) may blow air, but probably not all of them.

The geared motor, light motor, and air fountain all contain motors, used in different ways. Here they are connected in series, so the one that most resists the flow of electricity (needing the least electric current to operate) will dominate the circuit, restricting the electricity to the others. Often the geared motor will dominate, with the light motor and air fountain having electricity flowing through them but not enough to function properly, but your results may vary.

WARNING: Moving parts. Do not touch the fan during operation.





Project 120

Lots at Once

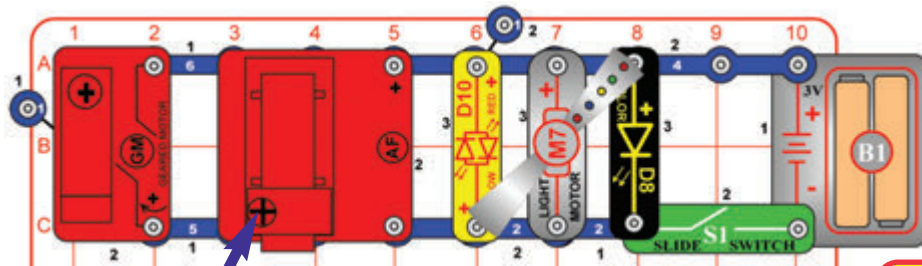

Build the circuit, but note that the air fountain (AF) is placed over the middle of the 5-snap and 6-snap wires. Place the spout on top of the air fountain and place the ball in it.

Lots of stuff should be happening - the geared motor (GM) shaft spins, the ball in the air fountain moves (it may rise into the air, or may just spin around), the light motor (M7) spins and lights, and the LEDs (D8 & D10) are on.

You may place the merry-go-round base on the geared motor, but this is not necessary.

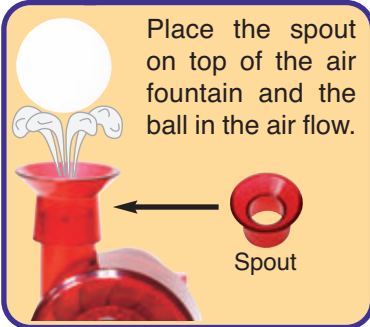

Here five components (GM, AF, D10, M7, & D8) are all connected in parallel, so the electric currents flowing through them can be different, and they are basically independent of each other. Electricity flows out of the batteries, divides among the five components, then recombines to flow through the switch and back into the batteries. Each component gets what it needs from the batteries (unless the batteries are too weak to supply enough), and all work properly. Also, if one breaks, the others keep working.

Note: this circuit connects the LEDs (D8 & D10) directly to the batteries without a resistor or other device to limit the current. Normally this could damage an LED, but your Boffin LEDs have internal resistors added to protect them from incorrect wiring, and will not be damaged. They are connected directly to the batteries in this circuit to help demonstrate how parallel circuits work.



Project 121

Electrical Circle

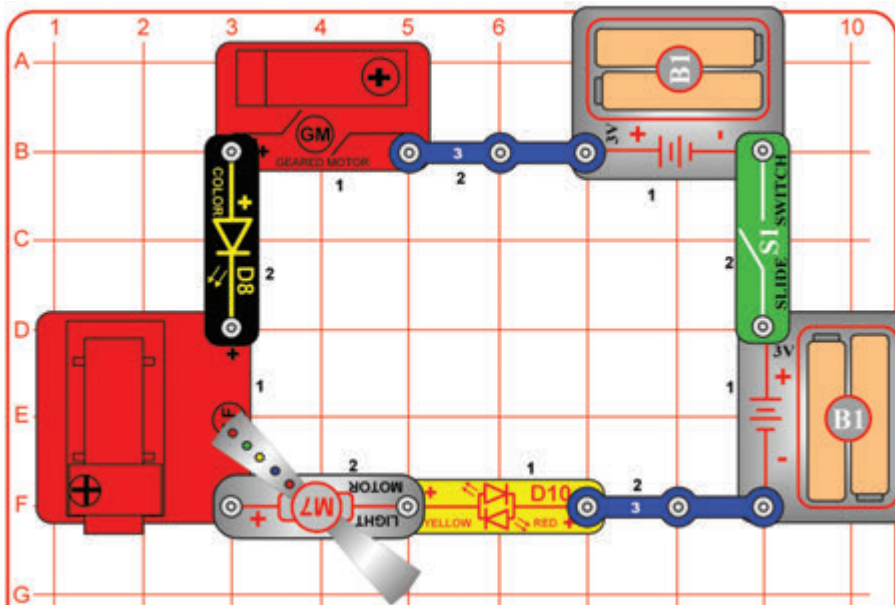

Rearrange the parts in the preceding circuit to make this one, which has them connected in a loop. Turn on the slide switch (S1). The LEDs (D8 & D10) light, but the geared motor (GM), air fountain (AF), and light motor (M7) do nothing. Snappy knows why.



Compare this circuit to the preceding one. Here the same five components (GM, AF, D10, M7, & D8) are all connected in series, so the electric current flowing through them must be the same, and each affects the others. Electricity flows in a loop, from the batteries, through each component, and then back into the batteries. Here the component with the most resistance limits the flow of electricity. In this circuit the LEDs (D8 & D10) have the most resistance due to their internal protection resistors (see above). The geared motor, air fountain, and light motor are unable to function because the LED resistance limits the current too much, though the electrical resistance of these devices is having an additional small limiting effect on the current flow.

A second battery holder was added to this circuit because the combined turn-on voltage of both LEDs (about 1.5V each) may be too high to make anything happen with just one set of batteries (3V). You can try replacing one battery holder with a 3-snap wire and see if the LEDs turn on.

Connecting parts in series makes the wiring less complex (especially important when the components are far apart), makes it easier to protect sensitive devices, and can avoid wasting energy (making batteries last longer).



Project 122

Generator

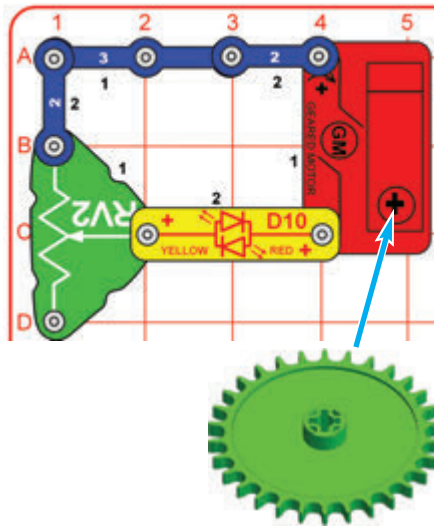

Normally, the geared motor uses electricity to create mechanical motion. This circuit uses the geared motor in reverse, to use mechanical motion (from you spinning the shaft) to create electricity (to light the LED).

Nearly all of the electricity used in our world is produced at enormous generators driven by steam or water pressure. Wires are used to efficiently transport this energy to homes and businesses where it is used. Motors convert the electricity back into mechanical form to drive machinery and appliances.

Build the circuit shown, and mount the 2.55" gear on the geared motor (GM). GENTLY spin the gear with your hand in both directions while watching the red/yellow bicolor LED (D10). The adjustable resistor (RV2) controls the LED brightness, set it towards the 2-snap wire for brightest. Do not try to spin the gear with too much force or you may break the geared motor.



Project 123 Leverage

Use the preceding circuit but replace the 2.55" with one of the others. Be GENTLE when turning the gear or you may break the geared motor (GM). Compare how much easier or harder it is to turn and light the LED.

The larger the gear, the easier it is to turn the shaft and light the LED. The size of the gear amplifies your power to turn the shaft.

Compare this to using a wrench to tighten or loosen a nut on a bolt. The wrench gives you leverage, increasing your turning power.

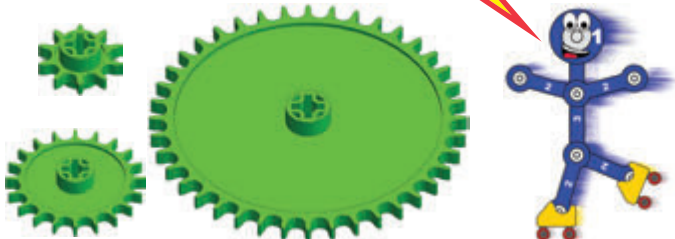

Project 124 Generator Load

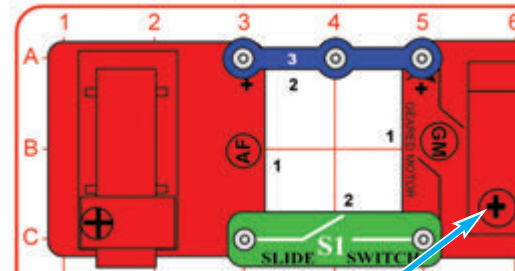

Build this circuit, and mount the 2.55" gear on the geared motor (GM). GENTLY spin the gear with your hand with the slide switch (S1) both on and off. Compare how difficult it is to turn whether the switch is on or off. You can also try this with different gears. Do not try to spin the gear with too much force or you may break the geared motor.

You may notice air flowing in or out of the air fountain (AF), but otherwise it won't do anything. It is not necessary or recommended to place the spout or ball on the air fountain.



It should be more difficult to spin the gear when the switch is on, because the air fountain is acting as a heavy electrical "load" or burden on the geared motor. Powering the air fountain takes more energy than powering nothing (such as when the switch is off) or powering an LED (like in the preceding circuits).



Project 125

Water Alarm

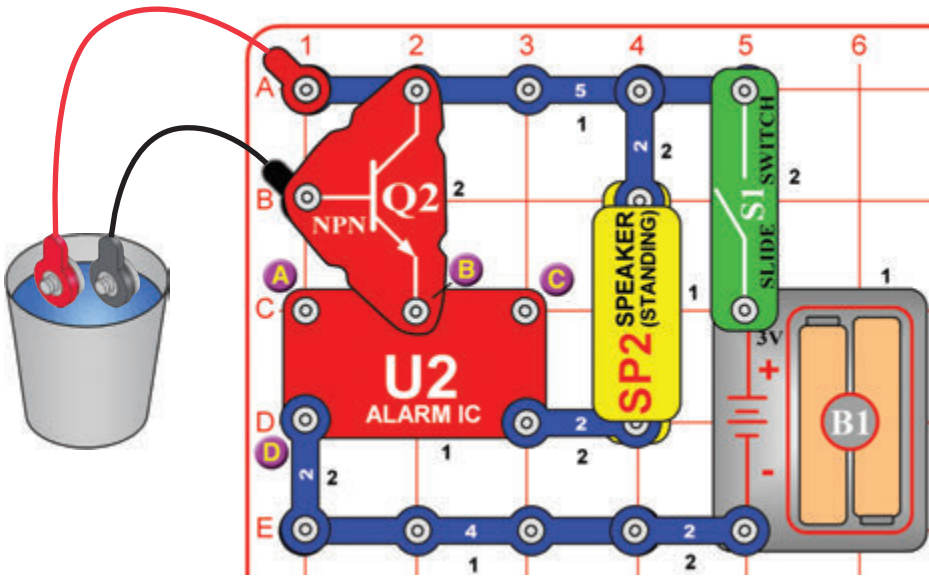

Build the circuit shown but initially leave the red & black jumper wires outside the cup. Turn on the slide switch (S1); nothing happens. Place the jumper wires into a cup of water and an alarm sounds!

Variants:

- Change the sound by using a 1-snap wire and a 2-snap wire to make a connection across points A & B, or A & D, or B & C.
- Remove the NPN transistor (Q2) and instead connect the black jumper wire at point B.

Don't drink any water used here.

Water has higher electrical resistance than the resistors in this set (RV2, and in the pivot stand), but much less than air. The NPN transistor acts as an amplifier, to help overcome water's resistance.

You could use longer wires and lay them on your basement floor, if your basement floods during a storm, then this circuit will sound an alarm!



Project 126 Human Alarm

Use the preceding circuit but instead of putting the red & black jumper wires in the water, touch the metal ends of them with your fingers. You may have to hold them tightly or wet your fingers to make this work.

Your body is mostly water, so it also has more resistance than the resistors in this set, but much less than water.



Project 127 Draw an Alarm

Use the circuit from project 125, but omit the cup of water and leave the loose ends of the jumpers unconnected for now. There is one more part you need and you are going to draw it. Take a pencil (No. 2 lead is best but other types will also work). **SHARPEN IT**, and fill in the shape below. You will get better results if you place a **hard**, flat surface directly beneath this page while you are drawing. Press **hard** (but don't rip the paper), and fill in the shape **several times** to be sure you have a **thick, even layer** of pencil lead.



Press the metal ends of the jumper wires on the shape and move them around over the drawing. If you don't hear any sound then move the ends closer together and move over the drawing, add another layer of pencil lead, or put a drop of water on the jumper ends to get better contact. with your fingers.

The black core of pencils is graphite, the same material used in the resistors in RV and the pivot stand.





Project 128

Human & Water Light

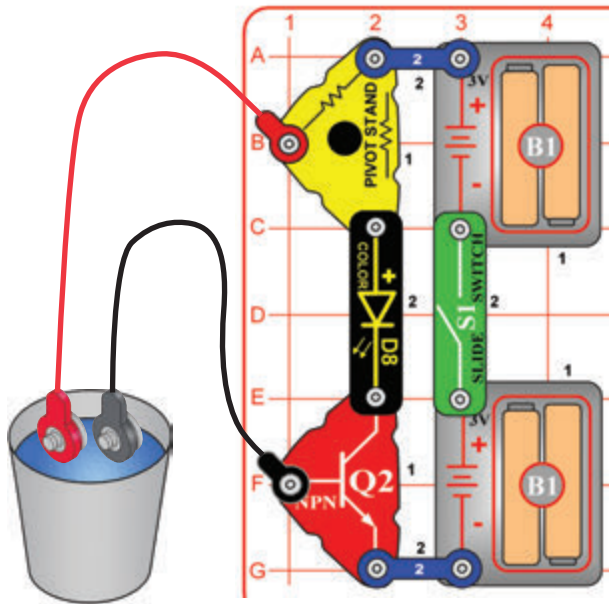

Build the circuit and turn on the switch (S1). Touch the metal in the jumper wire snaps with your fingers; the color LED (D8) should light. If the LED is dim or off, hold the metal more tightly or wet your fingers.

Next, place the loose ends of the jumper wires in a cup of water, make sure the metal parts aren't touching each other. The water should light the LED.

Don't drink any water used here.



Project 129

Conduction Detector

Use the preceding circuit but replace the color LED (D8) with the red/yellow bicolor LED (D10, oriented in either direction). Touch it with your fingers and put it in water as in the preceding project. Next, touch the ends of the jumper wires to different materials in your home, and see which ones light the LED.

The color LED can be used instead of the red/yellow LED, but the red/yellow LED isn't changing colors, so may be easier to compare if the LED only lights dimly.

Materials like metal conduct electricity well and will light the LED. Plastics, wood, and fabrics are poor conductors and will not light the LED.



Project 130

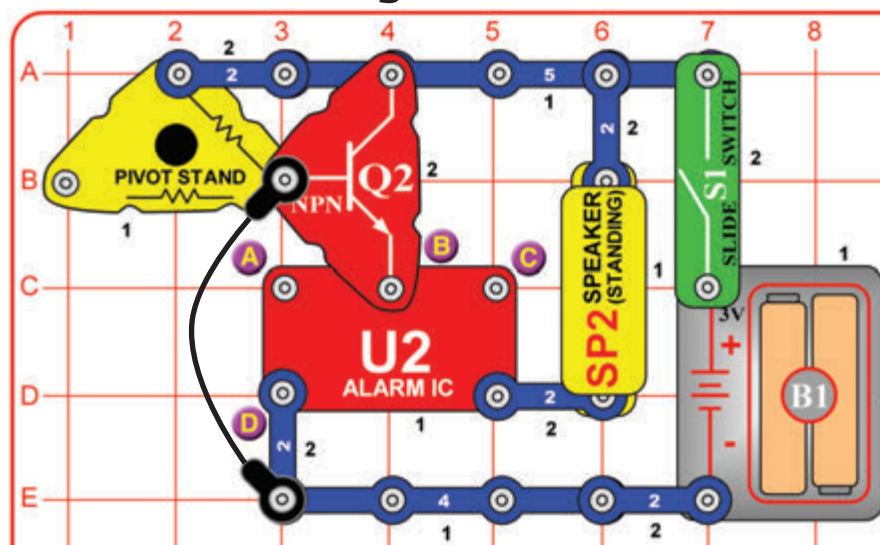

Trip-Wire Alarm

Build the circuit shown and turn on the slide switch (S1). Nothing happens. Break the black jumper wire connection and an alarm sounds. You could replace the black jumper wire with a longer wire and run it across a doorway to signal an alarm when someone enters.

You can change the sound by using a 1-snap wire and a 2-snap wire to make a connection across points A & B, or A & D, or B & C.



Project 131

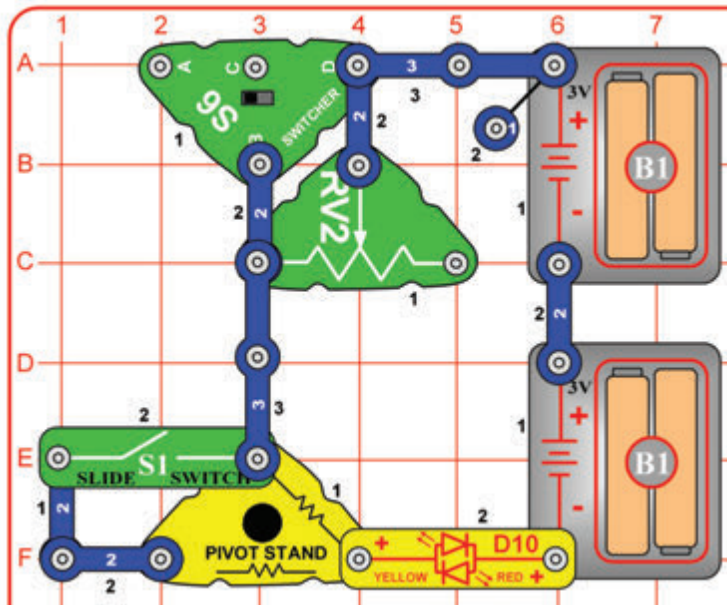

Current Limiters

Build the circuit, turn off the slide switch (S1) and set the switcher (S6) to the middle position. The red/yellow bicolor LED (D10) is on, and you can use the adjustable resistor (RV2) to vary its brightness a little.

The LED is not very bright because the circuit has two resistors limiting the electric current through it (a 10,000 ohm resistor in the pivot stand and RV2, which is adjustable between 200 ohms and 10,000 ohms).

Now turn on S1. The LED is brighter, and RV2 can vary the brightness more than before.

S1 connects a much smaller 47 ohm resistor (also in the pivot stand) in parallel with the 10,000 ohm resistor in the pivot stand. The smaller resistor does not limit the current flow as much as the larger one, so the LED is brighter.

Now set S6 to the right position. The LED is even brighter now, and RV2 no longer changes the brightness.

S6 bypasses RV2, allowing more current to flow, and making the LED brighter.

This circuit does not have an on/off switch, so disconnect it or remove the batteries when you are finished.



Project 132

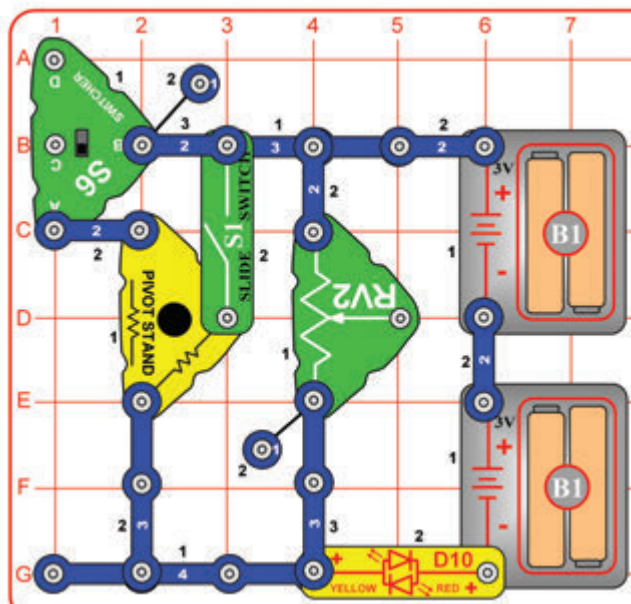

Current Limiters in Parallel

Build the circuit, turn off the slide switch (S1) and set the switcher (S6) to the middle position. The red/yellow bicolor LED (D10) is on dimly.

The LED is not very bright because the only electrical path from the batteries to the LED is through a 10,000 ohm resistor (the adjustable resistor, which is used here as a fixed 10,000 resistor, and cannot be adjusted).

Now turn on S1. The LED is a little brighter.

S1 connects a 10,000 ohm resistor in the pivot stand in parallel with RV2 (fixed at 10,000 ohms here). This gives two 10,000 ohm paths from the batteries to the LED, instead of just one, so the current is higher and the LED is brighter.

Now set S6 to the bottom position. The LED is much brighter now.

S6 connects a 47 ohm resistor in the pivot stand in parallel with the two 10,000 ohm resistors already in the circuit (one in the pivot stand and one in RV2). This adds a much lower 47 ohm path between the batteries and the LED, so a lot more current flows, and the LED is much brighter.

This circuit does not have an on/off switch, so disconnect it or remove the batteries when you are finished.



Project 133

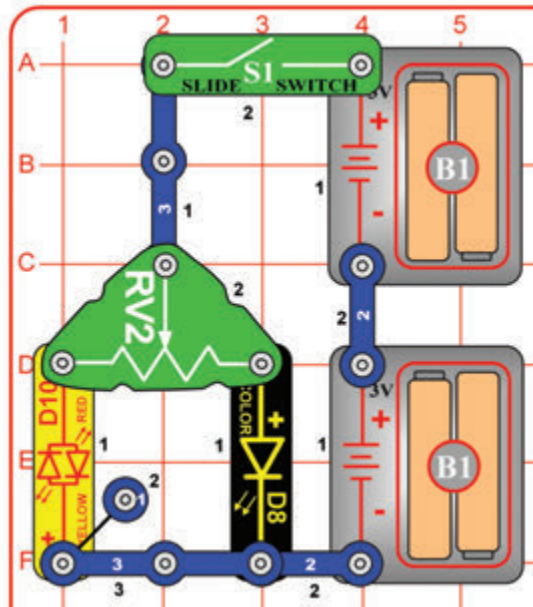

Current Director

Turn on the slide switch (S1) and adjust the brightness of the LEDs (D8 & D10) with the adjustable resistor (RV2).

The adjustable resistor (RV2) has a total of 10,000 ohms between the center and the two sides, with the lever setting how much is on each side.



Project 134

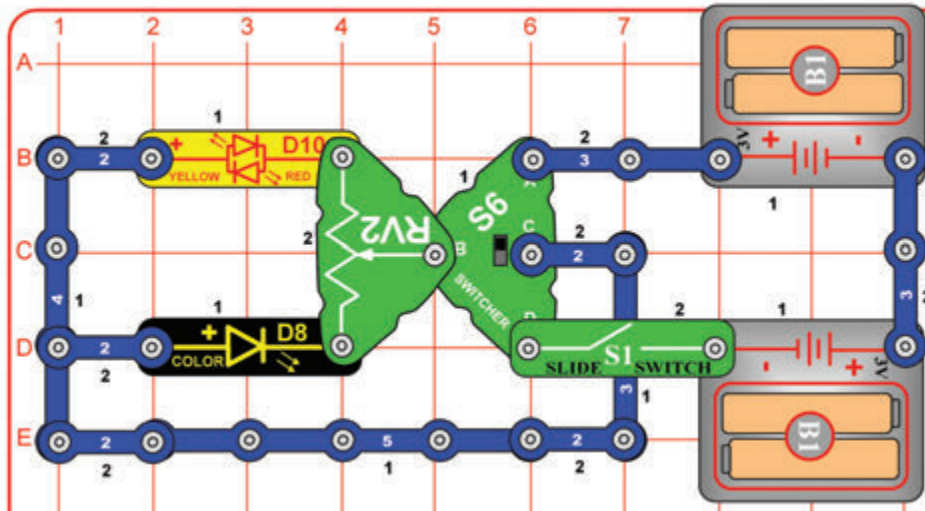

Reversible Current Director

Turn on the slide switch (S1), set the switch (S6) to the top or bottom position, and adjust the brightness of the LEDs (D8 & D10) with the adjustable resistor (RV2).

The red/yellow bicolor LED will light in both directions, but the color LED (D8) only works in one direction.

Project 135

Lazy Fan

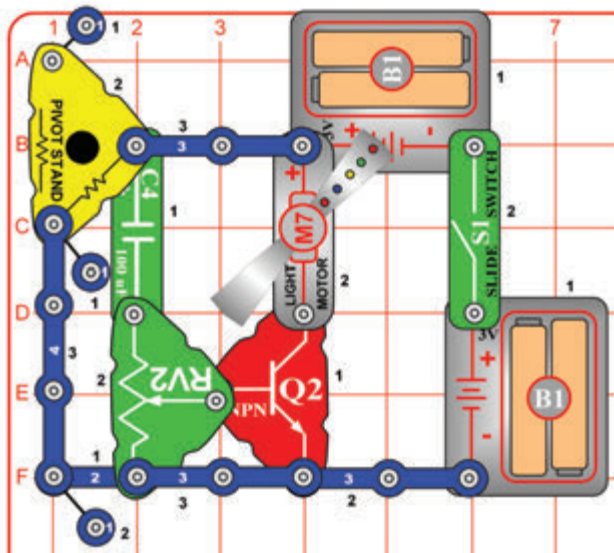

Set the adjustable resistor (RV2) to the top setting and keep it there. Turn on the slide switch (S1). The fan on the light motor (M7) spins briefly and stops. Now turn off the slide switch, wait a little while, and then turn it back on. The fan spins briefly again. Try this several times.

It is as if the fan is lazy, and can only spin a short time before it gets tired and has to stop and rest.

When you turn on the slide switch, the fan spins while the 100µF capacitor (C4) charges up, then stops. When you turn off the slide switch, the capacitor takes about 20 seconds to fully discharge.



Project 136

Lazy Merry-Go-Round

Use the preceding circuit but replace the light motor (M7) with the geared motor (GM, "+" on top). Install cardboard figures in the merry-go-round base and place the base on the geared motor. The circuit works the same way but spins the merry-go-round instead of the fan.

Project 137

Lazy Lights

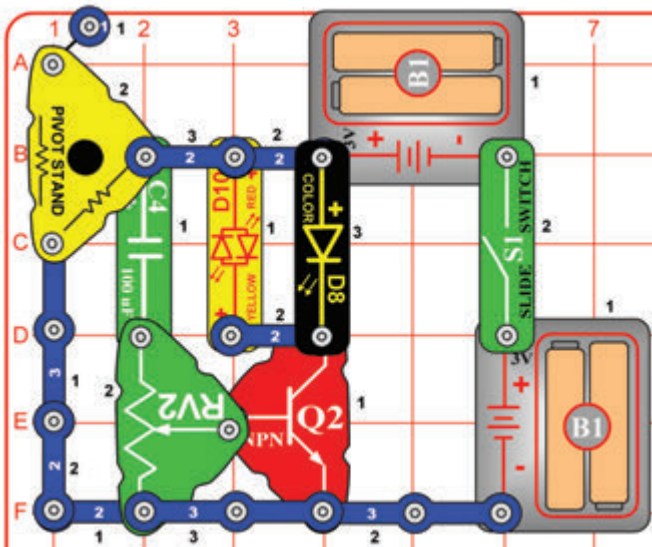

Set the adjustable resistor (RV2) to the top setting. Turn on the slide switch (S1). The LEDs (D8 & D10) light for a few moments. Now turn off the slide switch, wait a little while, and then turn it back on. The LEDs light briefly again. Try this several times.

It is as if the LEDs are lazy, and can only light for a short time before they get tired and have to turn off and rest.

Try this with different settings for RV2.

Project 138

Very Lazy Lights

Use the preceding circuit but replace the 100µF capacitor (C4) with the much smaller 1µF capacitor (C7). Now the LEDs only flash for a brief moment, because C7 can't store as much electricity as C4 did.



Project 139

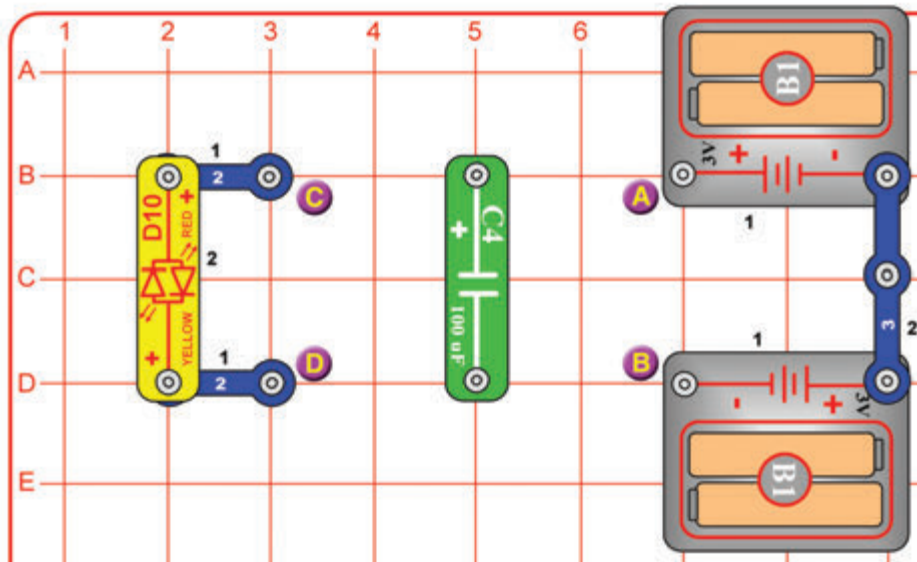

Electricity You Can Walk Away With

This circuit has two parts; build it as shown, but initially place the 100µF capacitor (C4) across points A & B. Then pick up C4 and place it across points C & D; the red/yellow bicolor LED (D10) flashes. Move C4 between points A/B & C/D several times.

In either location, C4 may be oriented in either direction, but its direction determines the color of the LED flash.

You can replace the 100µF capacitor with the smaller 1µF capacitor (C7), but the LED flash will be much dimmer.

Placing the capacitor across points A & B charges it up, and placing it across points C & D discharges it through the LED. Once charged, capacitors hold their charge well - you can charge up the capacitor, walk away with it for a while, then use it to light the LED.

Despite the "+" marking, connecting your capacitors backwards across your batteries in this circuit will not harm them.



Project 140

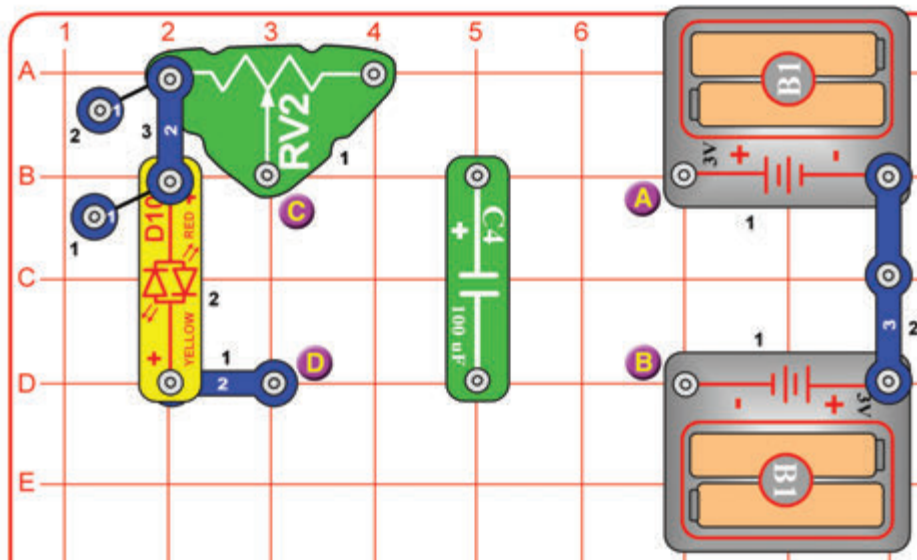

Electricity You Can Walk Away With (II)

Modify the preceding circuit to match this one. It works the same way, except the adjustable resistor (RV2) slows down the capacitor discharge, making the LED dimmer but stay on longer. Try this at different RV2 settings.



Project 141

Short Burst Machine Gun

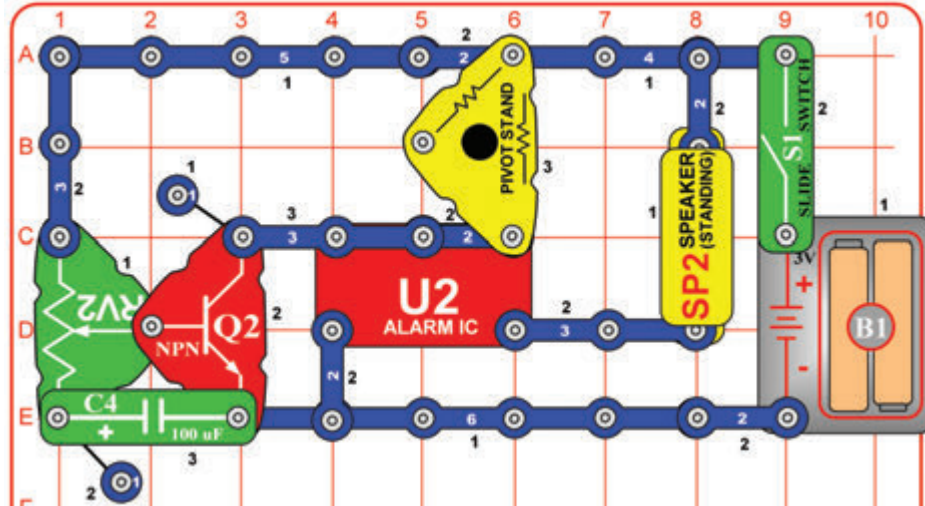

Set the adjustable resistor (RV2) to the bottom position. Turn on the slide switch (S1). A machine gun sounds for a second, then stops. Turn off the slide switch, wait a few seconds, then turn it back on to hear the machine gun sound again. Try this several times.



Project 142

Short Burst Sound & Lights

Use the preceding circuit but replace the 3-snap wire between the alarm IC (U2) and speaker (SP2) with the color LED (D8, "+" on right) or the red/yellow bicolor LED (D10, in either orientation). The sound will not be as loud now.



Project 143

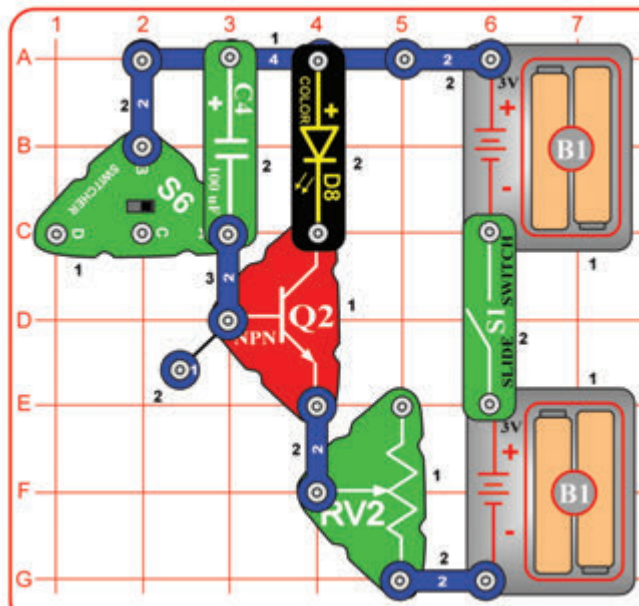

Short-On Light

Set the adjustable resistor (RV2) to the bottom position, and set the switcher (S6) to the middle position. Turn on the slide switch (S1). The color LED (D8) should light for a short while then go out. To reset the timer for the light to stay on, set S6 to the right position for a moment, then back to the middle position.

Moving the lever on RV2 up makes the LED dimmer but it stays on longer.

When you turn on the slide switch, the color LED lights while the 100µF capacitor (C4) charges up, then stops. Setting S6 to the right position discharges C4.

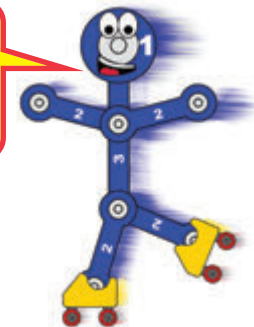



Project 144

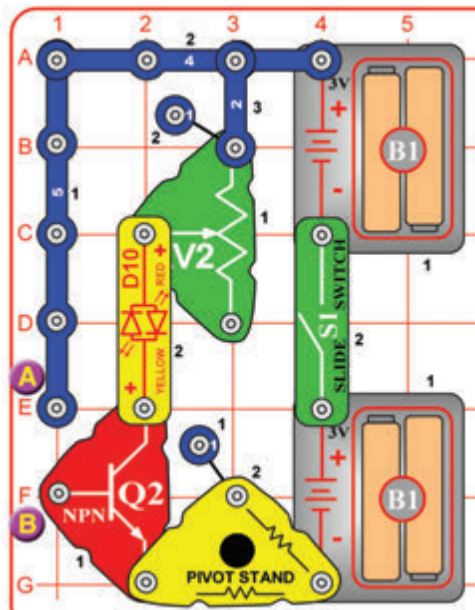

Finger Touch Light

Set the adjustable resistor (RV2) to the top position, and turn on the slide switch (S1). Turn on the red/yellow bicolor LED (D10) by touching your fingers between points A & B. You may need to press hard or wet your fingers to make the LED bright.

You can adjust the LED brightness using the lever on RV2, or replace the red/yellow LED with the color LED (D8).

Electricity flowing through your fingers is amplified by the NPN transistor (Q2), and is enough to turn on the LED. If the contacts at points A & B were interweaved as shown below then you could make this work with just one finger.

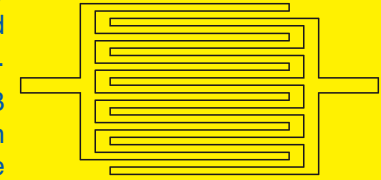

Project 145 Slow Off Light

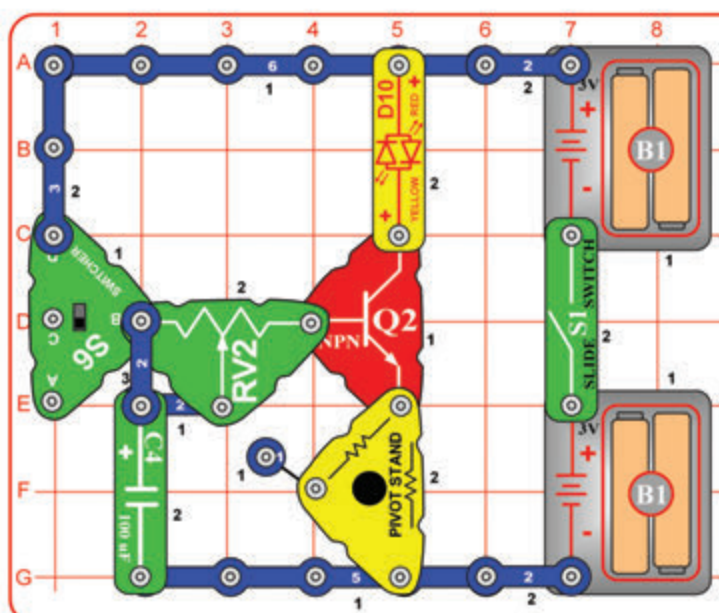

Set the switcher (S6) to the top position and turn on the slide switch (S1). The red/yellow bi-color LED (D10) is on. Now set S6 to the middle position and wait; the LED goes off after a little while. The adjustable resistor (RV2) can adjust how quickly the light goes out.



Project 146 3-Position Switch

The switcher (S6), has 3 positions. In this circuit, one position turns on the red/yellow LED (D10), one turns on the color LED (D8), and one turns both LEDs off.

You can change the color on D10 by reversing its orientation.

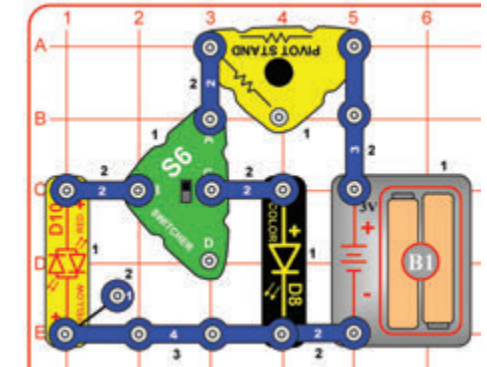



Project 147

One Way Electricity

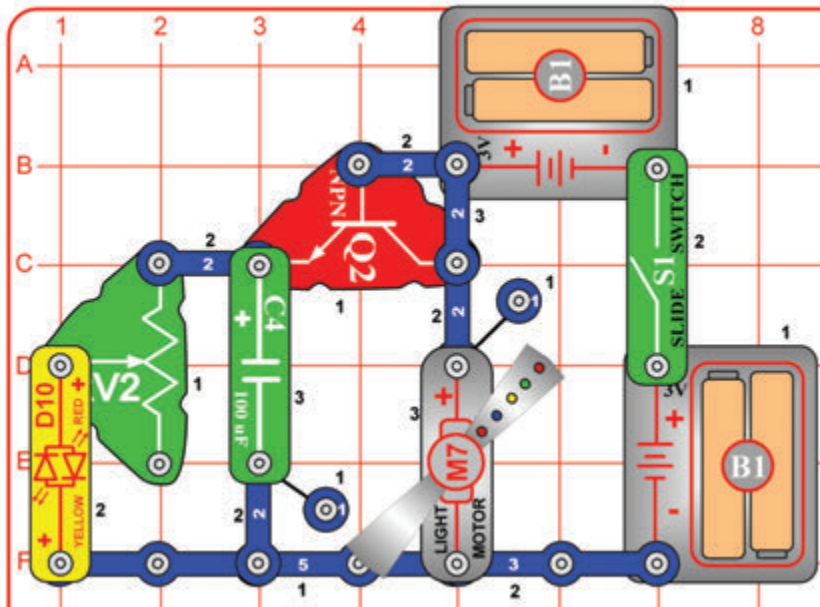

Turn on the slide switch (S1). The red/yellow bicolor LED (D10) and light motor (M7) are on. The adjustable resistor (RV2) sets the brightness for D10.

When you turn off the slide switch, the lights on the light motor go off immediately, but the red/yellow LED goes out slowly. RV2 sets how quickly the red/yellow LED goes out.

The NPN transistor (Q2) is used here as a diode. A diode only lets electricity flow in one direction.

When you turn off the switch, the red/yellow LED stays on for a little while as the 100µF capacitor (C4) discharges through it. The “diode” lets electricity flow from the batteries to the capacitor, but blocks electricity from flowing from the capacitor to the light motor. Without the diode the red/yellow LED and light motor would turn off immediately after the switch is turned off, because the low resistance of the light motor would discharge the capacitor in an instant.



Project 148

Tilt Sound & Light

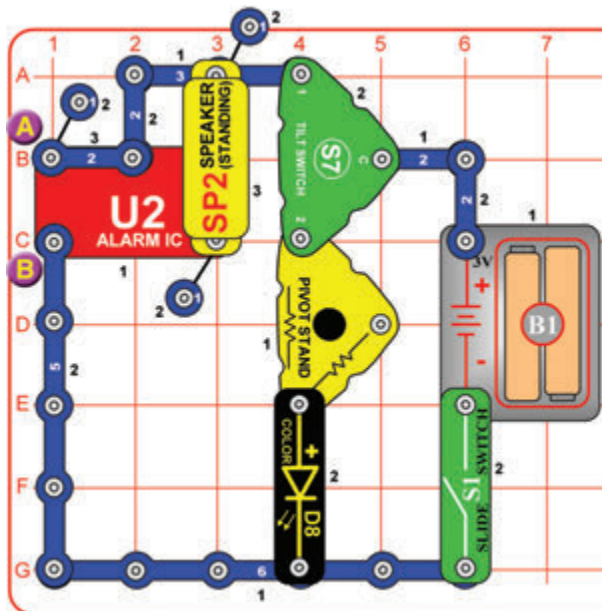

Build the circuit and turn on the slide switch (S1). A siren will sound or a light will shine if the circuit is tilted or moved. Experiment to see which tilt angles activate which effects.

If the circuit does not shut off when left alone, then tilt it slightly so it turns off.

Variants: You can change the sound by removing the 1-snap and 2-snap wires that are at point A, or by moving them to be across points A & B. You can also replace the color LED (D8) with the red/yellow bicolor LED (D10, oriented in either direction).



Project 149

Inflator

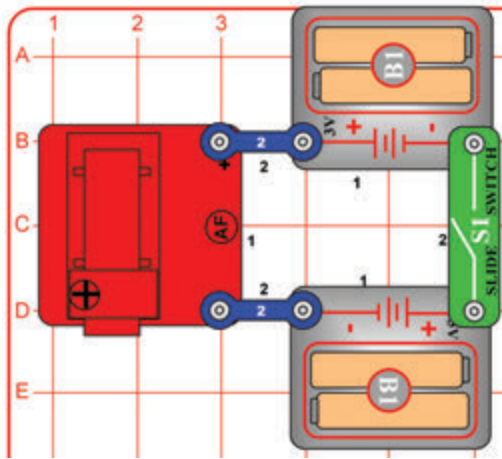

This project requires use of some household materials. Build the circuit shown, then get an adult to help you attach a latex glove (not included) or similar to the spout for the air fountain using a rubber band (one is included, or use one from your home), as shown. Place the spout and glove on the air fountain and turn on the slide switch (S1). Air should be blowing into the glove, making it inflate. You may be able to “wave” the glove by turning the slide switch on and off.

Be sure your rubber band makes a good seal on the spout, that allows air to flow into the glove without much escaping. You may have to try it several times to get it working properly.

You can try this with different materials around your home. Do not use a balloon, because the air fountain will not have enough air pressure to inflate it.

WARNING: Be careful not to use anything that could get sucked into the air intake on the side of the air fountain as this may damage the air fountain.



Project 150

Transistor

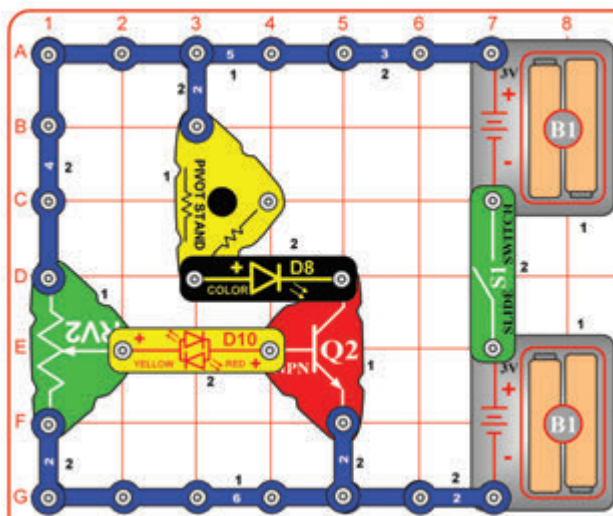

Build the circuit and turn on the slide switch (S1). Slowly move the lever on the adjustable resistor (RV2) across its range while watching the brightness of the red/yellow & color LEDs (D8 & D10).

Transistors, such as the NPN transistor (Q2), can amplify electric currents. In this circuit, the adjustable resistor controls a small current going to the transistor through the red/yellow LED. The transistor uses this small current to control a larger current through the color LED. At some RV2 settings, the control current is too small to light the red/yellow LED, but the transistor-amplified is large enough to light the color LED.





Project 151

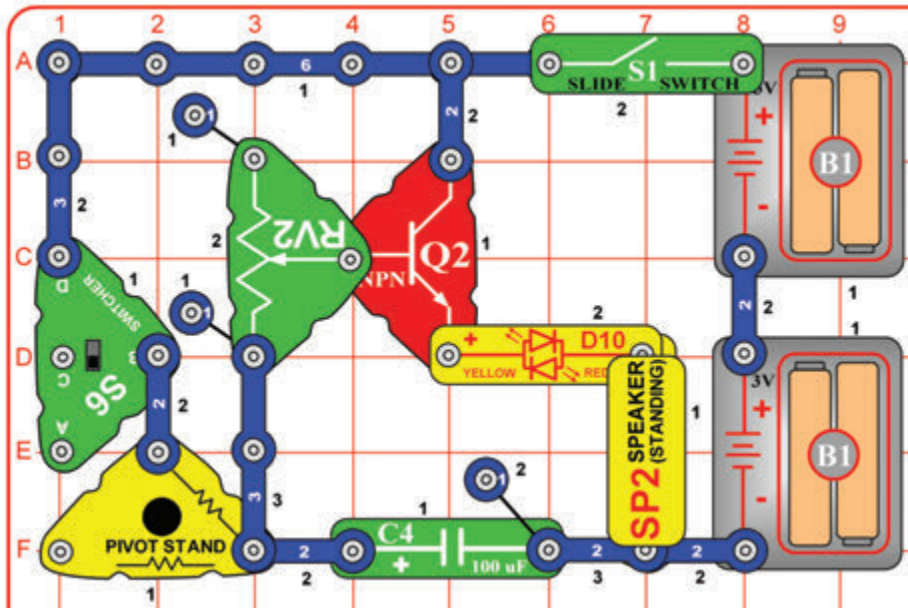

Slow Light

Set the switcher (S6) to the middle position. Turn on the slide switch (S1), nothing happens. Now set S6 to the top position; the red/yellow bicolor LED (D10) takes a few seconds to turn on. Now set S6 back to the middle position; the LED will very slowly get dim. The adjustable resistor (RV2) controls the shut-off time.

You can reverse the orientation of the red/yellow bicolor LED, or replace it with the color LED (D8, "+" on left).

The 100µF capacitor (C4) controls the red/yellow LED through the NPN transistor (Q2). Setting S6 to the top position quickly charges up the capacitor, and setting S6 back to the middle position allows the capacitor to slowly discharge. Capacitors can store electric charge and release it when needed, so they are often used in timing circuits like this.



Project 152

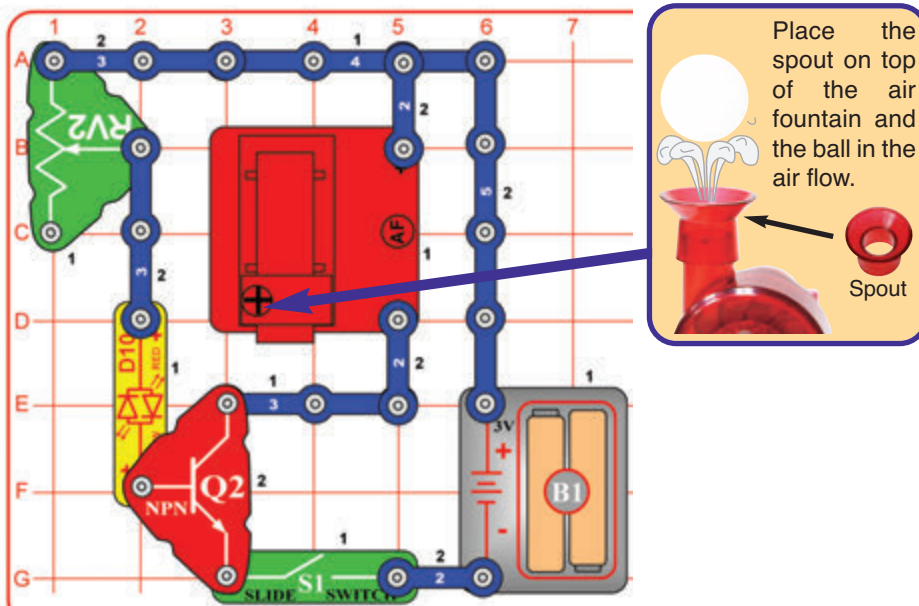

Wiggler

Build the circuit as shown, place the spout on the air fountain (AF), place the ball in the spout, set the lever on the adjustable resistor (RV2) to the top, and turn on the slide switch (S1). Use the lever on the adjustable resistor to adjust the brightness of the red/yellow bicolor LED (D10) and make the ball move or "wobble" around in the spout.

The ball will only move for a small part of RV2's adjustment range. If you replace the red/yellow LED with a 3-snap wire, the ball will move more.

This circuit uses the NPN transistor (Q2) and adjustable resistor (RV2) to control the power to the air fountain. A small electric current into the transistor through RV2 and the LED (D10) controls a larger current into the transistor through the air fountain. RV2 cannot be used to control the air fountain directly, because its high resistance would prevent the air fountain from operating.



Project 153

Blinker Beeper

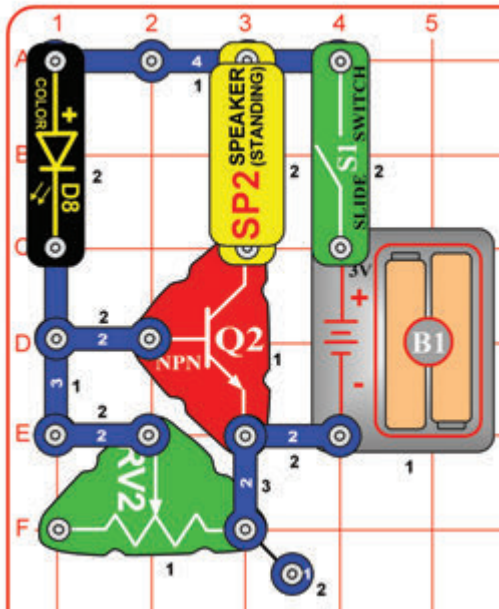

Build the circuit as shown and turn on the switch (S1). The color LED (D8) will be blinking and you hear beeping from the speaker (SP2). The adjustable resistor (RV2) can adjust the sound and LED brightness a little.

The color LED (D8) has a microcircuit that changes the light colors. As it does this, it changes the current through the circuit. The transistor (Q2) amplifies the changing current and uses it to control the speaker (SP2).



Project 154

Blinker Blinker

Use the preceding circuit, but replace the speaker (SP2) with the red/yellow bicolor LED (D10, in either orientation). Now the red/yellow LED will also be blinking.

Project 155

Blinker Control

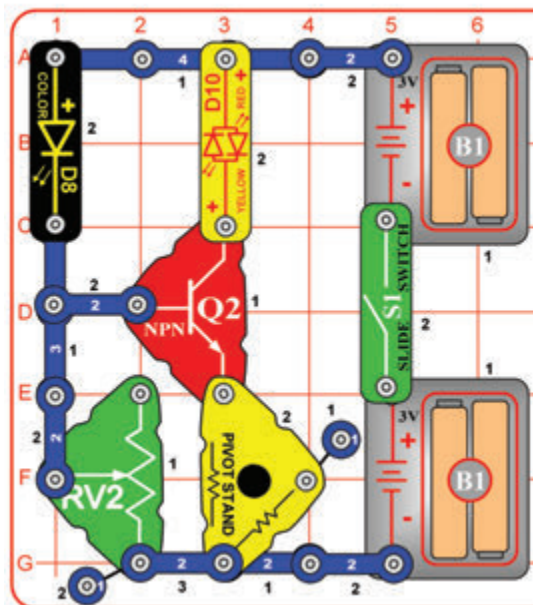

Build the circuit as shown and turn on the switch (S1). The color LED (D8) and red/yellow bicolor LED (D10) will both be blinking. The color LED will be brighter than in the preceding circuit. The adjustable resistor (RV2) can change the color LED brightness a little.

The red/yellow LED is controlled by the color LED using the transistor (Q2). If you remove the color LED from the circuit then the red/yellow LED will not light. Removing the red/yellow LED will not affect the color LED.

Try swapping the locations of the color & red/yellow LEDs, reversing the orientation of the red/yellow LED, or replacing the red/yellow LED with the speaker (SP2).



Project 156

Red Lights First

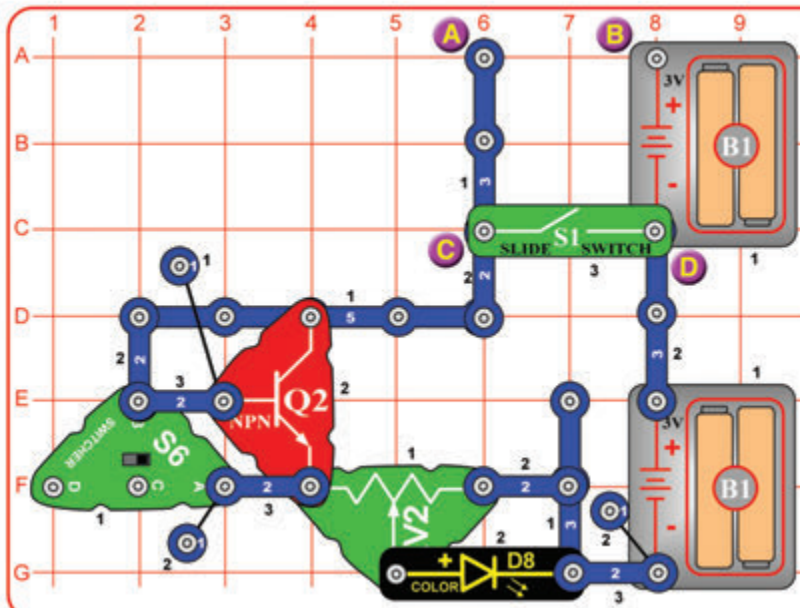

Set the switcher (S6) to the middle position and turn on the slide switch (S1). Set the lever on the adjustable resistor (RV2) all the way to the left. The color LED (D8) should be on, but may be mostly red. Slowly move the lever on RV2 to the right until the LED is completely off. Notice that the red color stays on the longest.

Now set S6 to the right position and adjust RV2 again, watching the LED colors. Blue and green color may also appear now, but may go dim before red does.

Now move S1 from the points marked C & D to the points marked A & B and set S6 back to the middle position. Move RV2's lever around again, watching the LED colors and brightness. Set S6 to the right position again, and notice that the LED now lights for a much larger part of RV2's adjustment range.

The voltage needed to turn on an LED depends on the light color. Red needs the least voltage, and blue needs the most. With S1 at points C & D and S6 in the middle position, the voltage to the color LED is lowest, and may barely be enough to turn on the red color. Setting S6 to the right position bypasses the NPN transistor (Q2), and boosts the LED voltage a little. Shifting S1 to points A & B increases the circuit voltage from 3V to 6V, making the LED work for a greater part of RV2's range.



Project 157

Red Just Before Yellow

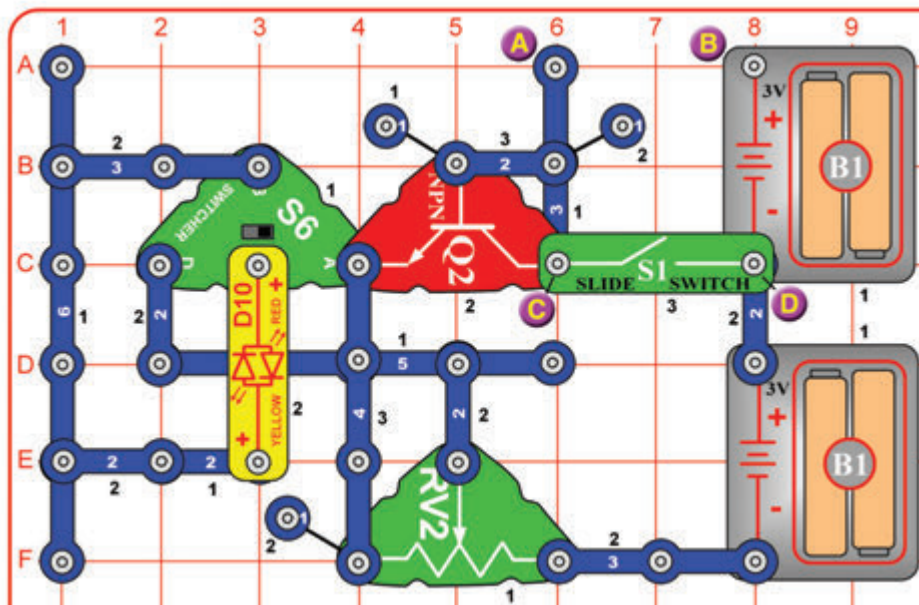

Turn on the slide switch (S1). Set the switcher (S6) to both the left & right positions at several settings on the adjustable resistor (RV2), and compare the brightness of the red/yellow bicolor LED (D10). See if you can notice a difference in the LED brightness between red and yellow, especially when the LED is very dim.

Now move S1 from the points marked C & D to the points marked A & B. Move RV2's lever around again while changing S6 between left and right, comparing the LED colors and brightness.

Yellow light is just slightly easier for the red/yellow bicolor LED to produce than red light. If you look closely at the LED when it is dim, then you may notice that red color is slightly brighter than yellow.





Project 158

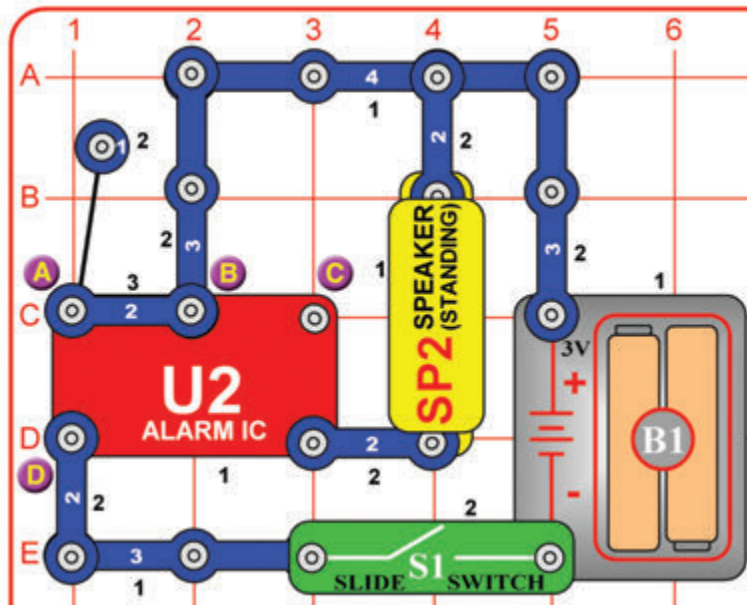

Build the circuit and turn on the slide switch (S1). You hear a siren.
 Variants: You can change the sound by removing the 1-snap and 2-snap wires that are at point A, or by moving them to be across points B & C, or across points A & D.



Project 159

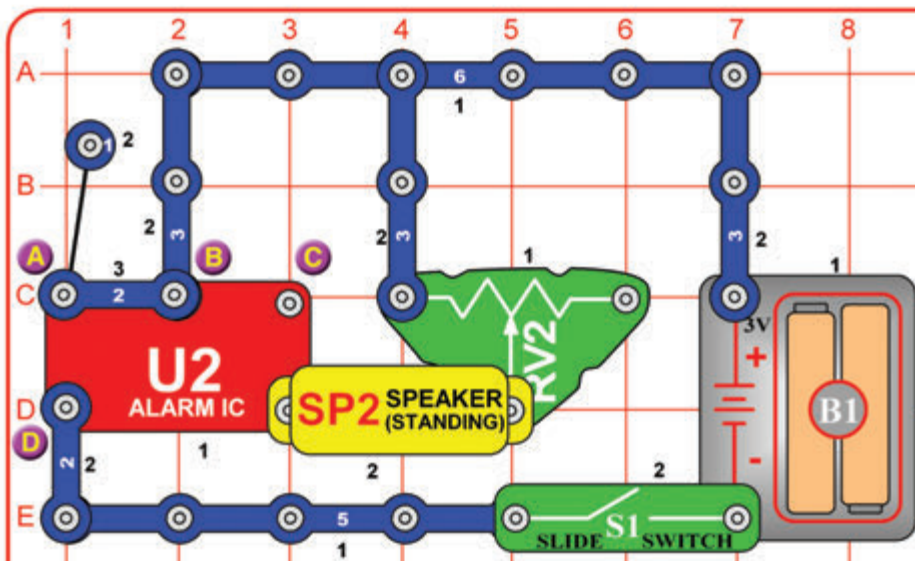

Adjustable Volume Sirens

The preceding circuit may be too loud, so modify it to match this one, which uses the adjustable resistor (RV2) as a volume control. Turn on the slide switch (S1) and adjust the volume using RV2.

Variants: You can change the sound by removing the 1-snap and 2-snap wires that are at point A, or by moving them to be across points B & C, or across points A & D.



Project 160

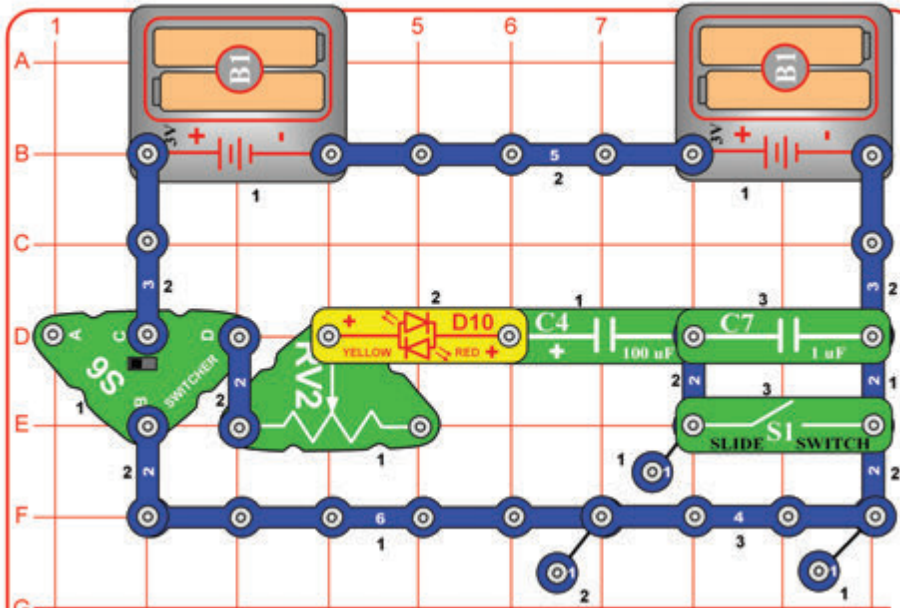

Capacitors in Series

Initially set the adjustable resistor (RV2) to the left, and the slide switch (S1) to on. Set the switch (S6) to the left position; the red/yellow bicolor LED (D10) flashes brightly yellow as the 100µF capacitor (C4) charges up. Now set S6 to the right position; the LED flashes brightly red as C4 discharges. Try switching S6 to left and then to right several times.

Now set S1 to off; this connects the smaller 1µF capacitor (C7) in series with the 100µF capacitor. Now repeat switching S6 to left and then to right several times. The LED is much dimmer now, because the smaller capacitor can't store as much electricity, making the charging & discharging currents lower, which makes the LED dimmer.

Next, repeat the above tests but try moving the lever on the adjustable resistor around. Moving the lever on the adjustable resistor makes the capacitor charge/discharge more slowly, making the LED dimmer but it stays on longer.



Think of capacitors as storage tanks for electricity. If you place a small storage tank in series with a big one, electricity flows into both at the same time, but the small one fills up quickly and stops the flow.



Project 161

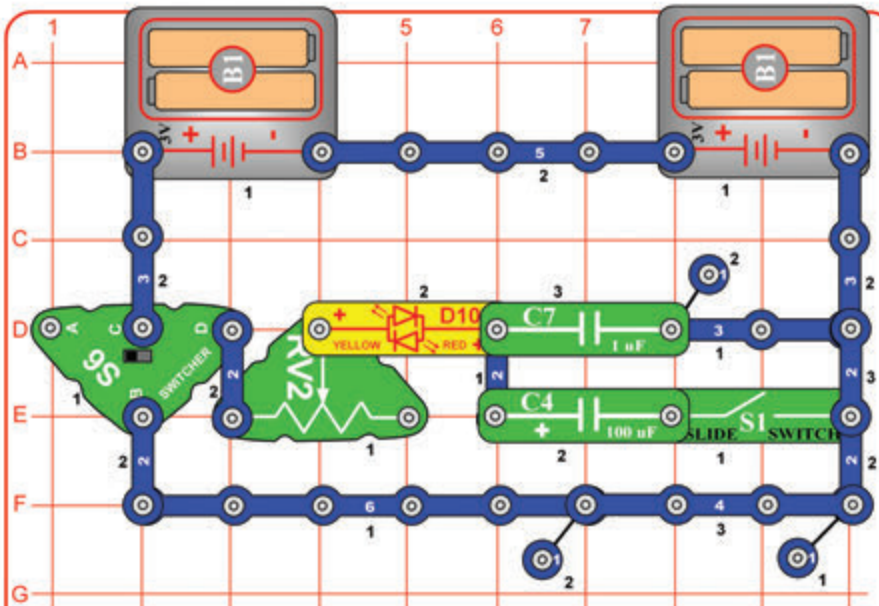

Capacitors in Parallel

Initially set the adjustable resistor (RV2) to the left, and the slide switch (S1) to off. Set the switch (S6) to the left position; the red/yellow bicolor LED (D10) flashes dimly yellow as the 1µF capacitor (C7) quickly charges up. Now set S6 to the right position; the LED flashes dimly red as C7 quickly discharges. Try switching S6 to left and then to right several times.

Now set S1 to on; this connects the larger 100µF capacitor (C4) in parallel with the 1µF capacitor. Now repeat switching S6 to left and then to right several times. The LED is much brighter now, because the larger capacitor can store more electricity, making the charging & discharging currents higher, which makes the LED brighter.

Next, repeat the above tests but try moving the lever on the adjustable resistor around. Moving the lever on the adjustable resistor makes the capacitor charge/discharge more slowly, making the LED dimmer but it stays on longer.



Think of capacitors as storage tanks for electricity. If you place a large storage tank in parallel with a big one, electricity flows into both at the same time, but keeps flowing until both are full.



Project 162

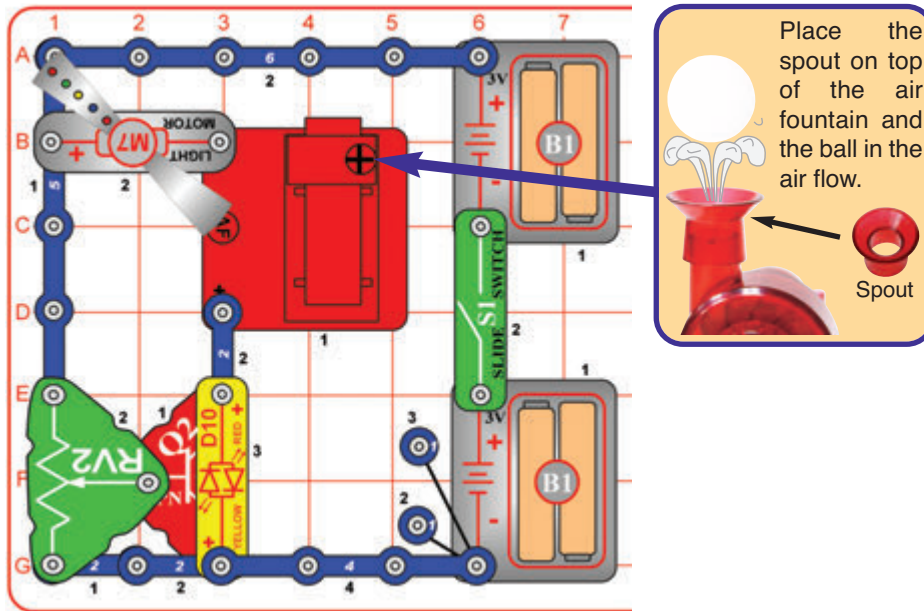

Adjustable Light Motor

Build the circuit as shown. Place the spout and ball on the air fountain (AF), and turn on the slide switch (S1). Use the lever on the adjustable resistor (RV2) to adjust the brightness of the LEDs in the light motor (M7) and red/yellow LED (D10), and to adjust the power to the air fountain. For best effects, dim the room lights. The ball may spin on the air fountain but may not rise into the air. New batteries are recommended for this project.

Be sure to try this at very low light levels (where the motor is barely spinning), as there some cool effects. If the fan on the light motor doesn't spin, try giving it a push to get started.



WARNING: Moving parts. Do not touch the fan during operation.



Project 163

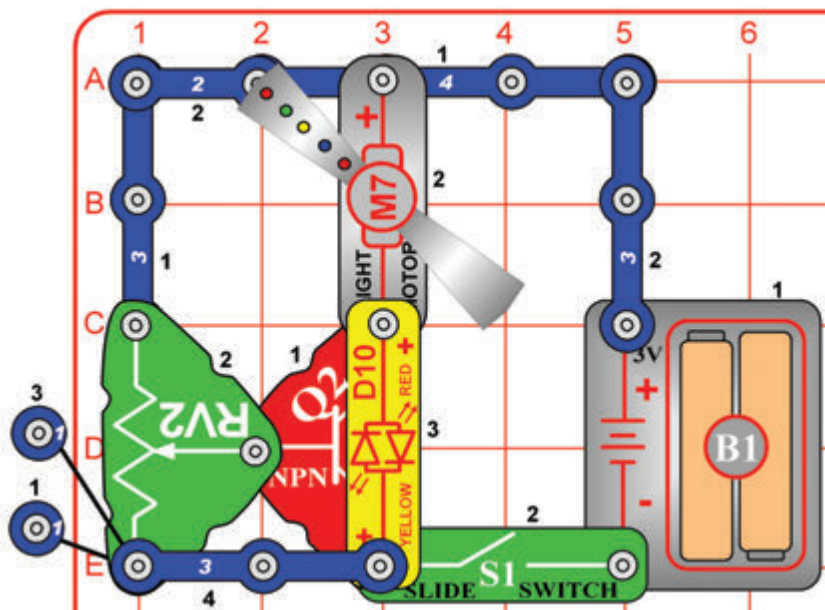

Adjustable Low Speed Fan

Turn on the slide switch (S1) and adjust the fan speed for the light motor (M7) using the lever on the adjustable resistor (RV2). Initially set RV2 to the top to get the motor started; if the fan does not start even at the top RV2 setting then give it a push to get started. The fan will only spin for a small part of RV2's adjustment range. The red/yellow bicolor LED (D10) will usually light when the fan is not spinning.

New batteries are recommended for this project.

Note: Do not modify this circuit to use both battery holders as this may reduce the life of your parts.



WARNING: Moving parts. Do not touch the fan during operation.



Project 164

Transistor Control

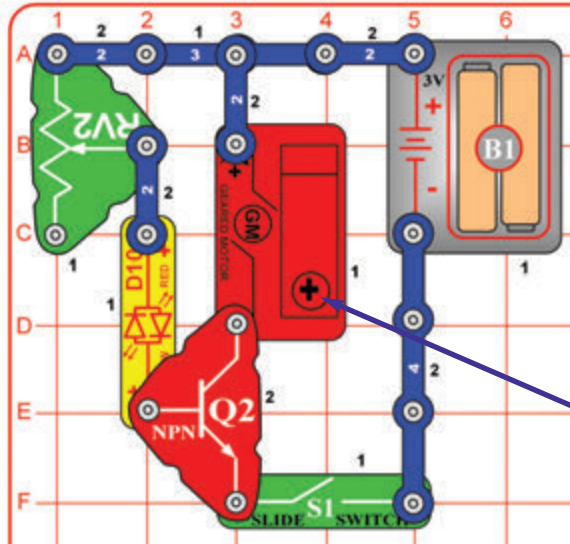

Insert some of the cardboard figures into the 3 slots on the edge of the merry-go-round base. Build this circuit and mount the merry-go-round base onto the shaft on the geared motor (GM).

Set the lever on the adjustable resistor (RV2) to the top. Turn on the slide switch (S1), and use the lever on the adjustable resistor to set the brightness of the red/yellow bicolor LED (D10) and the speed of the merry-go-round base.

The merry-go-round will only spin for a small portion of RV2's adjustment range. If it does not spin even at the top RV2 setting then give it a gentle push clockwise to get started.

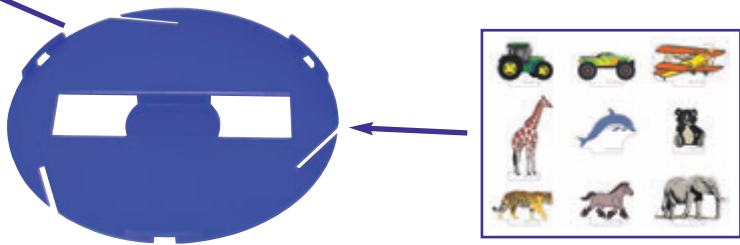

This circuit uses the NPN transistor (Q2) and adjustable resistor (RV2) to control the speed of the geared motor (GM). A small electric current into the transistor through RV2 and the LED (D10) controls a larger current into the transistor through the geared motor. RV2 cannot be used to control the geared motor directly, because its high resistance would prevent the geared motor from operating.



Project 165

Reversible Motor

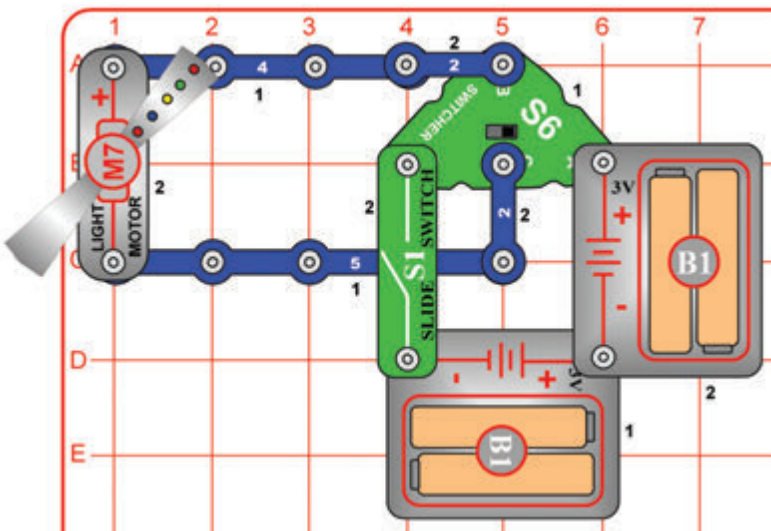

Build the circuit, turn on the slide switch (S1), and set the switcher (S6) to the left or right to control the light motor (M7).

In the light motor (M7), the motor spins in both directions but the LED light circuit only works in one direction. LEDs are like little one-way light bulbs.



Project 166

Slow Reversible Motor

Use the preceding circuit, but replace one of the battery holders (B1) with a 3-snap wire. Now the motor spins slower and the lights are dimmer.



Project 167

Orange Light

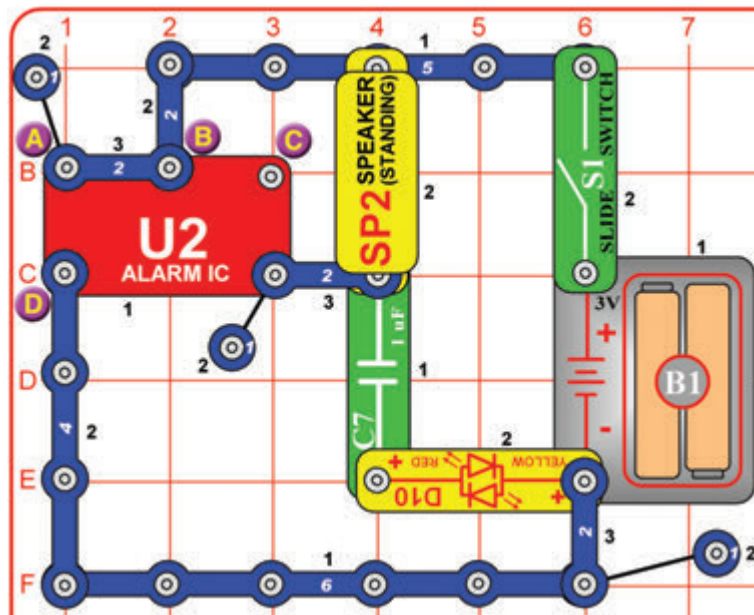

Turn on the slide switch (S1). Look at the red/yellow bicolor LED (D10) in a dimly lit room. What color is the LED?

Variants: You can change the sound by removing the 1-snap and 2-snap wires that are at point A, or by moving them to be across points B & C, or across points A & D. The LED color may also appear to change slightly.

The color on the LED is a blend of red & yellow, and looks like orange.
 The alarm IC (U2) is turning on and off rapidly to create the siren sound pattern heard from the speaker (SP2), and this also causes the 1µF capacitor (C7) to be charged and discharged rapidly. The LED is yellow when C7 is charging, and red when C7 is discharging. The color is changing so fast that it appears orange to your eyes.



Project 168

Light, Sound, & Flight?

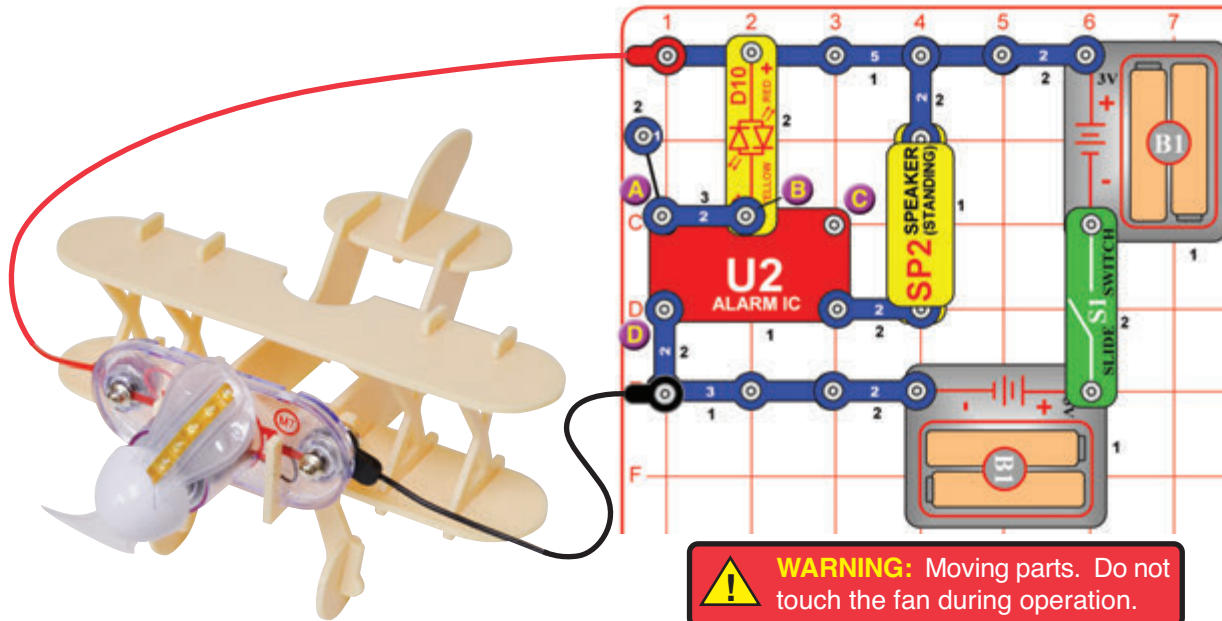

Assemble the airplane using the instructions on page 5, install the light motor (M7) into the front of it, build the circuit shown here, and connect the red & black jumper wires to the light motor (red to "+"). Spread out the jumper wires and be sure they will not interfere with the fan on the light motor.

Place the airplane on a smooth surface and turn on the slide switch (S1). The fan on the light motor spins and lights, a siren is heard, and the airplane slowly moves around due to vibration.

Variants: You can change the sound by removing the 1-snap and 2-snap wires that are at point A, or by moving them to be across points B & C, or across points A & D.

WARNING: Moving parts. Do not touch the fan during operation.

BOFFIN

More Boffin building sets are available at:
www.boffin.cz

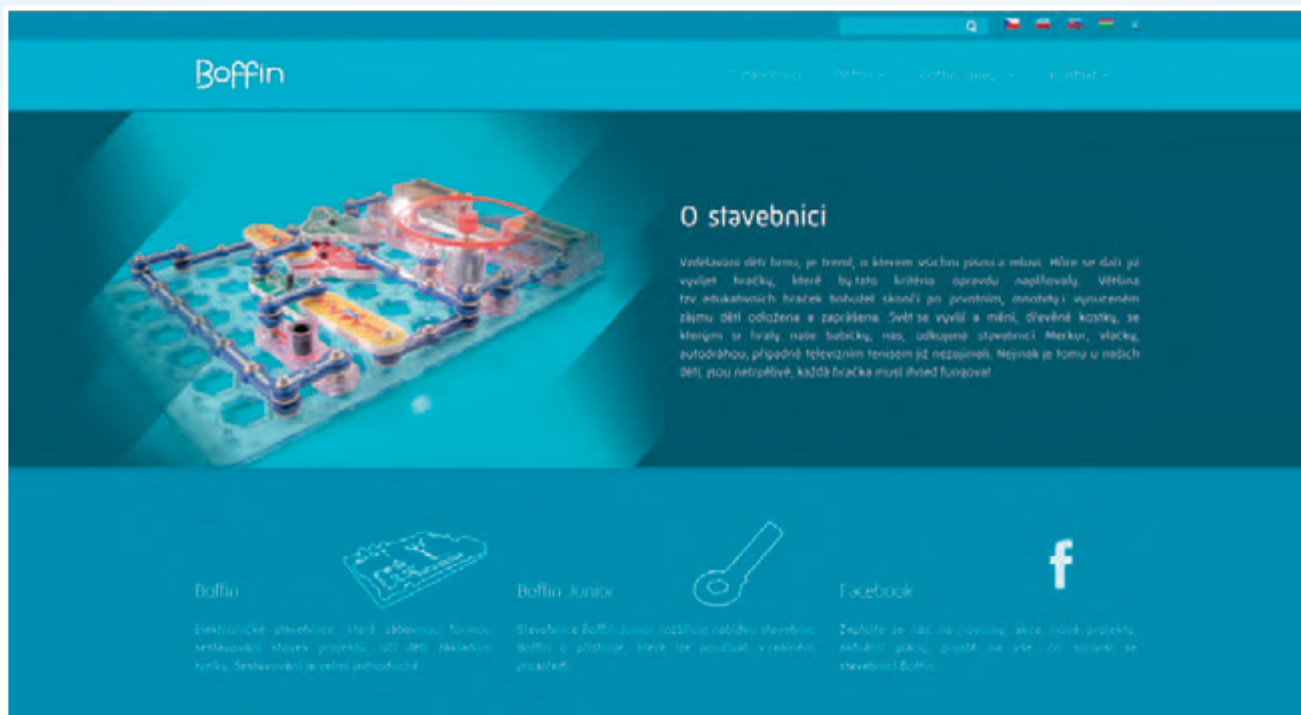

Boffin

0 stavebnici

Vedlejší díly jsou, je trend, a kterým učebny jsou a mládež. Může se dít, že vyvíjet hračky, které by tato kritéria operedu naplněvaly. Většina tzv. edukativních hraček totiž sestává ze prvků, mnohdy i vyrobených z kovu, které jsou složena a zapřátna. Svět se vyvíjí a mění, dřevěné kostky, se kterými se hrály naše babičky, nás, odkopané stavebnici Merkur, vtačky, autodiáhou, případně televizním tenisem již nezažijeme. Nejinak je tomu u našich dětí, jsou natříděné, každá hračka musí ihned fungovat.

Boffin

Boffin - Jurace

Facebook

Elektronické stavebnice - Mladé zručnosti, tvorbu, uměleckou, slovesní, projekt, učí děti, kreativní, fyziku, Senzorevní, je velmi jednoduchá.

Stavebnice Boffin Junior rozšiřuje možnosti stavebnice Boffin o přístroje, které lze používat v reálném prostředí.

Zapojte se řád na různých akce, soutěže, projekty, soutěže, akce, projekt, na vše, co souvisí se stavebnicí Boffin.

ConQuest entertainment a. s.
Kolbenova 961, 198 00 Praha 9,
www.boffin.cz, www.toy.cz
info@boffin.cz



WWW.TOY.CZ